



Where Automation Connects.



inRAX[®]

MVI56-WA-PWP

ControlLogix Platform

Wireless Communication Module

3/16/2009

USER MANUAL

Important Installation Instructions: Radio Modules

The following Information and warnings pertaining to the radio module must be heeded:

- A** "THIS DEVICE CONTAINS A TRANSMITTER MODULE, FCC ID: SDZ-WA-1. PLEASE SEE FCC ID LABEL ON BACK OF DEVICE."
- B** "THIS DEVICE USES AN INTERNAL COMPACT FLASH RADIO MODULE AS THE PRIMARY RADIO COMPONENT. THE COMPACT FLASH RADIO MODULE DOES NOT HAVE AN FCC ID LABEL. THE COMPACT FLASH RADIO MODULE HAS NO USER SERVICABLE PARTS."
- C** "THIS DEVICE COMPLIES WITH PART 15 OF THE FCC RULES. OPERATION IS SUBJECT TO THE FOLLOWING TWO CONDITIONS: (1) THIS DEVICE MAY NOT CAUSE HARMFUL INTERFERENCE, AND (2) THIS DEVICE MUST ACCEPT ANY INTERFERENCE RECEIVED, INCLUDING INTERFERENCE THAT MAY CAUSE UNDESIRE OPERATION."
- D** "THIS DEVICE AND ANY RADIO ACCESSORY SOLD BY PROSOFT MUST BE INSTALLED BY AN AUTHORIZED PROFESSIONAL INDUSTRIAL RADIO SYSTEM INTEGRATOR. FURTHER, ONLY RADIO ACCESSORIES SOLD BY PROSOFT AND SPECIFICALLY TESTED FOR USE WITH THIS DEVICE MAY BE USED WITH THIS DEVICE."
- E** "THE USER OF THIS EQUIPMENT CANNOT BE WITHIN 20 cm. FROM THE RADIATING ELEMENT DEVICE."
- F** "CHANGES OR MODIFICATIONS NOT EXPRESSLY APPROVED BY THE PARTY RESPONSIBLE FOR COMPLIANCE COULD VOID THE USER'S AUTHORITY TO OPERATE THE EQUIPMENT."

Industry Canada Requirements:

- A** "THIS DEVICE HAS BEEN DESIGNED TO OPERATE WITH AN ANTENNA HAVING A MAXIMUM GAIN OF 24 dB. AN ANTENNA HAVING A HIGHER GAIN IS STRICTLY PROHIBITED PER REGULATIONS OF INDUSTRY CANADA. THE REQUIRED ANTENNA IMPEDANCE IS 50 OHMS."
- B** "TO REDUCE POTENTIAL RADIO INTERFERENCE TO OTHER USERS, THE ANTENNA TYPE AND ITS GAIN SHOULD BE CHOSEN SUCH THAT THE EQUIVALENT ISOTROPICALLY RADIATED POWER (EIRP) IS NOT MORE THAN THAT REQUIRED FOR SUCCESSFUL COMMUNICATION."
- C** "THE INSTALLER OF THIS RADIO EQUIPMENT MUST INSURE THAT THE ANTENNA IS LOCATED OR POINTED SUCH THAT IT DOES NOT EMIT RF FIELD IN EXCESS OF HEALTH CANADA LIMITS FOR THE GENERAL POPULATION; CONSULT SAFETY CODE 6, OBTAINABLE FROM HEALTH CANADA."

WARNING:

This is a Class A product. In a domestic environment this product may cause radio interference in which case the user may be required to take adequate measures.

Battery Life Advisory

All modules in the MVI series use a rechargeable Lithium Vanadium Pentoxide battery to backup the 512K SRAM memory, real-time clock, and CMOS. The battery should last for the life of the module. The module must be powered for approximately twenty hours before it becomes fully charged. After it is fully charged, the battery provides backup power for the CMOS setup and configuration data, the real-time clock, and the 512K SRAM memory for approximately 21 days. Before you remove a module from its power source, ensure that the battery within the module is fully charged. A fully charged battery will hold the BIOS settings (after being removed from its power source) for a limited number of days. When the battery is fully discharged, the module will revert to the default BIOS settings.

Note: The battery is not user replaceable.

Agency Approval & Certification



243333

Wireless Approvals

Visit our website at <http://www.prosoft-technology.com> for current wireless approval information.

Your Feedback Please

We always want you to feel that you made the right decision to use our products. If you have suggestions, comments, compliments or complaints about the product, documentation or support, please write or call us.

ProSoft Technology

1675 Chester Avenue, Fourth Floor
Bakersfield, CA 93301
+1 (661) 716-5100
+1 (661) 716-5101 (Fax)
<http://www.prosoft-technology.com>

Copyright © ProSoft Technology, Inc. 2009. All Rights Reserved.

MVI56-WA-PWP User Manual
3/16/2009

ProSoft Technology®, ProLinx®, inRAx®, ProTalk® and RadioLinx® are Registered Trademarks of ProSoft Technology, Inc.

ProSoft® Product Documentation

In an effort to conserve paper, ProSoft Technology no longer includes printed manuals with our product shipments. User Manuals, Datasheets, Sample Ladder Files, and Configuration Files are provided on the enclosed CD and are available at no charge from our web site: <http://www.prosoft-technology.com>

Printed documentation is available for purchase. Contact ProSoft Technology for pricing and availability.

Asia Pacific: +603.7724.2080

Europe, Middle East, Africa: +33.5.34.36.87.20

Latin America: +1.281.298.9109

North America: +1.661.716.5100

Contents

Important Installation Instructions: Radio Modules	2
Battery Life Advisory	2
Agency Approval & Certification	3
Your Feedback Please.....	3
ProSoft® Product Documentation.....	3

Guide to the MVI56-WA-PWP User Manual 7

1 Start Here 9

1.1	System Requirements	9
1.2	Package Contents	10
1.3	Install ProSoft Configuration Builder Software	10
1.4	Setting Jumpers	12
1.5	Install the Antenna.....	12
1.6	Install the Module in the Rack	12
1.7	Connect your PC to the Processor.....	14
1.8	Download the Sample Program to the Processor.....	18

2 Configuring the MVI56-WA-PWP Module 21

2.1	ProSoft Configuration Builder.....	21
2.2	[Backplane Configuration]	27
2.3	[Radio Configuration].....	28
2.4	[Radio SNTP Client]	29
2.5	[RADIO PWP Exchanges].....	31
2.6	[Radio PWP Multicast Group List].....	35
2.7	Radio Ethernet Configuration (WATTCP)	36

3 Verify Radio Communications 39

3.1	Save and Download the Configuration File to the MVI56-WA-PWP	39
3.2	Save and Download the Configuration File to the 6104-WA-PDPM.....	41
3.3	Verify Data Exchange.....	42

4 Diagnostics and Troubleshooting 45

4.1	Reading Status Data from the Module	45
4.2	LED Status Indicators.....	58

5 Reference 61

5.1	Product Specifications.....	61
5.2	Functional Overview	63
5.3	Jumper and Wiring Settings	76
5.4	Exchange Configuration Form	80

6	Support, Service & Warranty	81
6.1	How to Contact Us: Technical Support.....	81
6.2	Return Material Authorization (RMA) Policies and Conditions.....	82
6.3	LIMITED WARRANTY	83
Index		89

Guide to the MVI56-WA-PWP User Manual

Function		Section to Read	Details
Introduction (Must Do)	→	Start Here (page 9)	This Section introduces the customer to the module. Included are: package contents, system requirements, hardware installation, and basic configuration.
Verify Communication, Diagnostic and Troubleshooting	→	Verifying Communication (page 39) Diagnostics and Troubleshooting (page 45)	This section describes how to verify communications with the network. Diagnostic and Troubleshooting procedures.
Reference Product Specifications Functional Overview Glossary	→	Reference (page 61) Functional Overview (page 63) Product Specifications (page 61)	These sections contain general references associated with this product, Specifications, and the Functional Overview.
Support, Service, and Warranty Index	→	Support, Service and Warranty (page 81)	This section contains Support, Service and Warranty information. Index of chapters.

1 Start Here

In This Chapter

- ❖ System Requirements 9
- ❖ Package Contents 10
- ❖ Install ProSoft Configuration Builder Software..... 10
- ❖ Setting Jumpers 12
- ❖ Install the Antenna..... 12
- ❖ Install the Module in the Rack 12
- ❖ Connect your PC to the Processor 14
- ❖ Download the Sample Program to the Processor..... 18

Installing the MVI56-WA-PWP module requires a reasonable working knowledge of the Rockwell Automation hardware, the MVI56-WA-PWP Module and the application in which they will be used.



Caution: It is important that those responsible for implementation can complete the application without exposing personnel, or equipment, to unsafe or inappropriate working conditions. Safety, quality and experience are key factors in a successful installation.

1.1 System Requirements

The MVI56-WA-PWP module requires the following minimum hardware and software components:

- Rockwell Automation ControlLogix processor, with compatible power supply and one free slot in the rack, for the MVI56-WA-PWP module. The module requires 800mA of available power.
- Rockwell Automation RSLogix 5000 programming software
- Rockwell Automation RSLinx Classic version 2.51 or newer communication software
- Pentium® II 450 MHz minimum. Pentium III 733 MHz (or better) recommended
- Supported operating systems:
 - Microsoft Windows XP Professional with Service Pack 1 or 2
 - Microsoft Windows 2000 Professional with Service Pack 1, 2, or 3
 - Microsoft Windows Server 2003
- 128 Mbytes of RAM minimum, 256 Mbytes of RAM recommended
- 100 Mbytes of free hard disk space (or more based on application requirements)

- 256-color VGA graphics adapter, 800 x 600 minimum resolution (True Color 1024 × 768 recommended)
- CD-ROM drive
- 802.11b compatible wireless adapter.

Note: You can install the MVI56-WA-PWP module in a local or remote rack, in any available slot in the rack.

1.2 Package Contents

The following components are included with your MVI56-WA-PWP module, and are all required for installation and configuration.

Important: Before beginning the installation, please verify that all of the following items are present.

Qty.	Part Name	Part Number	Part Description
1	MVI56-WA-PWP Module	MVI56-WA-PWP	Wireless Communication Module
1	Cable	Cable #15, RS232 Null Modem	For RS232 Connection to the CFG Port
1	Cable	RJ45 to DB9 Male Adapter	For DB9 Connection to Module's Port
1	Antenna	A2405S-OA	5dbi Omni Articulating Antenna
1	inRAX Solutions CD		Contains sample programs, utilities and documentation for the MVI56-WA-PWP module.

If any of these components are missing, please contact ProSoft Technology Support for replacement parts.

1.3 Install ProSoft Configuration Builder Software

You must install the ProSoft Configuration Builder (PCB) software in order to configure the MVI56-WA-PWP module. You can always get the newest version of ProSoft Configuration Builder from the ProSoft Technology web site.

To install ProSoft Configuration Builder from the ProSoft Web Site

- 1 Open your web browser and navigate to <http://www.prosoft-technology.com/pcb>
- 2 Click the **Download Here** link to download the latest version of ProSoft Configuration Builder.

- 3 Choose "Save" or "Save File" when prompted. The following illustrations show the file download prompt for two of the most common web browsers.

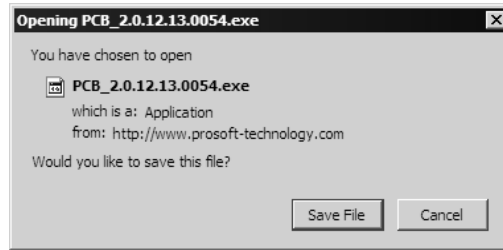

- 4 Save the file to your Desktop, so that you can find it easily when you have finished downloading.
- 5 When the download is complete, locate and open the file, and then follow the instructions on your screen to install the program.

If you do not have access to the Internet, you can install ProSoft Configuration Builder from the ProSoft Solutions CD-ROM, included in the package with your MVI56-WA-PWP module.

To install ProSoft Configuration Builder from the Product CD

- 1 Insert the ProSoft Solutions Product CD into the CD drive of your PC. Wait for the startup screen to appear.
- 2 On the startup screen, click *Product Documentation*. This action opens an explorer window.
- 3 Click to open the *Utilities* folder. This folder contains all of the applications and files you will need to set up and configure your module.
- 4 Double-click the *ProSoft Configuration Builder Setup* program and follow the instructions on your screen to install the software on your PC.

Note: Many of the configuration and maintenance procedures use files and other utilities on the CD-ROM. You may wish to copy the files from the Utilities folder on the CD-ROM to a convenient location on your hard drive.

1.4 Setting Jumpers

Note: The Setup Jumper acts as "write protection" for the module's flash memory. In "write protected" mode, the Setup pins are not connected, and the module's firmware cannot be overwritten. Do not jumper the Setup pins together unless you are directed to do so by ProSoft Technical Support.

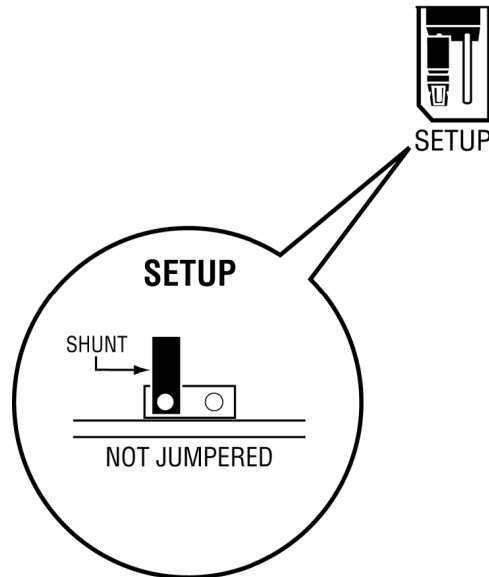

1.5 Install the Antenna

All antennas for radios communicating directly with each other should be mounted so they are within line-of-sight and have the same antenna polarity.

Antennas with a reverse polarity SMA connector can be mounted directly on the radio. Screw the antenna onto the antenna port connector until snug.

Antennas that do not have a reverse polarity SMA connector must be mounted separately and connected to the radio using a ProSoft RadioLinx adaptor cable. Because the antenna cable attenuates the RF signal, **use an antenna cable no longer than necessary to ensure optimum performance.**

Note: It is illegal to use any antenna that is not on the ProSoft Technology approved antennas list. Contact ProSoft Technology (page 3) with any questions or browse the antenna FAQ at <http://www.prosoft-technology.com>

1.6 Install the Module in the Rack

If you have not already installed and configured your ControlLogix processor and power supply, please do so before installing the MVI56-WA-PWP module. Refer to your Rockwell Automation product documentation for installation instructions.

Warning: You must follow all safety instructions when installing this or any other electronic devices. Failure to follow safety procedures could result in damage to hardware or data, or even serious injury or death to personnel. Refer to the documentation for each device you plan to connect to verify that suitable safety procedures are in place before installing or servicing the device.

After you have checked the placement of the jumpers, insert MVI56-WA-PWP into the ControlLogix™ chassis. Use the same technique recommended by Rockwell Automation to remove and install ControlLogix™ modules.

Warning: When you insert or remove the module while backplane power is on, an electrical arc can occur. This could cause an explosion in hazardous location installations. Verify that power is removed or the area is non-hazardous before proceeding. Repeated electrical arcing causes excessive wear to contacts on both the module and its mating connector. Worn contacts may create electrical resistance that can affect module operation.

- 1 Turn power OFF.
- 2 Align the module with the top and bottom guides, and slide it into the rack until the module is firmly against the backplane connector.

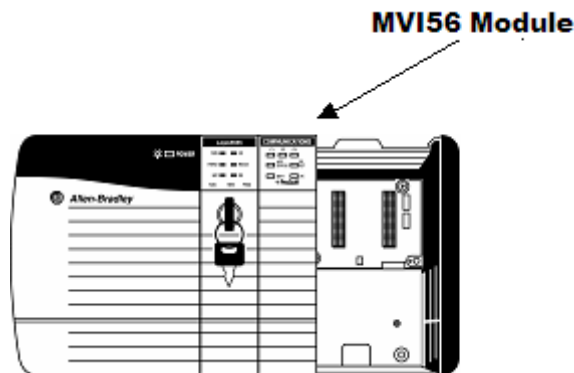

- 3 With a firm but steady push, snap the module into place.
- 4 Check that the holding clips on the top and bottom of the module are securely in the locking holes of the rack.
- 5 Make a note of the slot location. You will need to identify the slot in which the module is installed in order for the sample program to work correctly. Slot numbers are identified on the green circuit board (backplane) of the ControlLogix rack.
- 6 Turn power ON.

Note: If you insert the module improperly, the system may stop working, or may behave unpredictably.

Note: If you are installing MVI56-WA-PWP with other modules connected to the PCI bus, the peripheral modules will not have holding clips. Make sure all of the modules are aligned with their respective slots before you snap them into place.

1.7 Connect your PC to the Processor

- 1 Connect the right-angle connector end of the cable to your controller at the communications port.

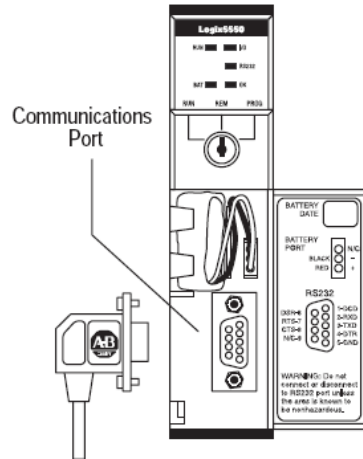

- 2 Connect the straight connector end of the cable to the serial port on your computer.

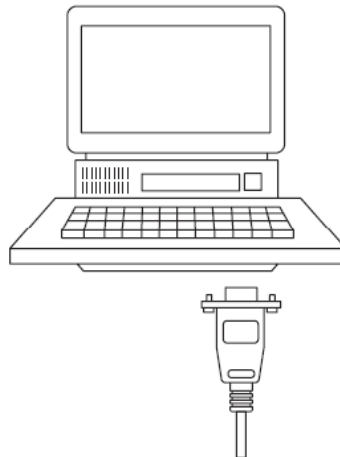

1.7.1 Sample Ladder Logic

Important: You must download the sample ladder to the ControlLogix processor, otherwise the module will be unable to establish communication with the processor.

If you see the message

"Waiting for connection to processor..."

when you connect to the configuration/debug port on the MVI56-WA-PWP module using ProSoft Configuration Builder, connect to the processor with RSLogix and download the sample ladder logic to the processor before continuing.

Open the Sample Ladder Logic in RSLogix

The sample program for your MVI56-WA-PWP module includes custom tags, data types and ladder logic for data I/O, status and monitoring. For most applications, you can run the sample ladder program without modification, or, for advanced applications, you can incorporate the sample program into your existing application.

The inRAx Solutions CD provides one or more versions of the sample ladder logic. The version number appended to the file name corresponds with the firmware version number of your ControlLogix processor. The firmware version and sample program version must match.

To determine the firmware version of your processor

Important: The RSLinx service must be installed and running on your computer in order for RSLogix to communicate with the processor. Refer to your RSLinx and RSLogix documentation for help configuring and troubleshooting these applications.

- 1 Connect an RS-232 serial cable from the COM (serial) port on your PC to the communication port on the front of the processor.
- 2 Start RSLogix 5000 and close any existing project that may be loaded.
- 3 Open the Communications menu and choose **Go Online**. RSLogix will establish communication with the processor. This may take a few moments.
- 4 When RSLogix has established communication with the processor, the Connected To Go Online dialog box will open.

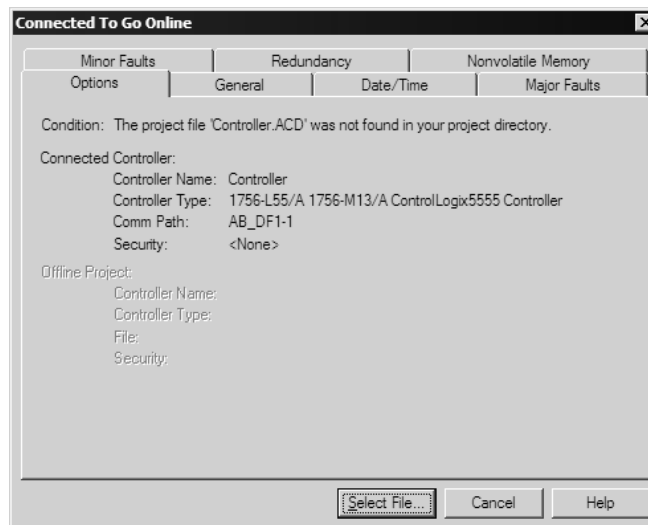

- 5 On the Connected To Go Online dialog box, click the General tab. This tab shows information about the processor, including the Revision (firmware) version. In the following illustration, the firmware version is 11.32

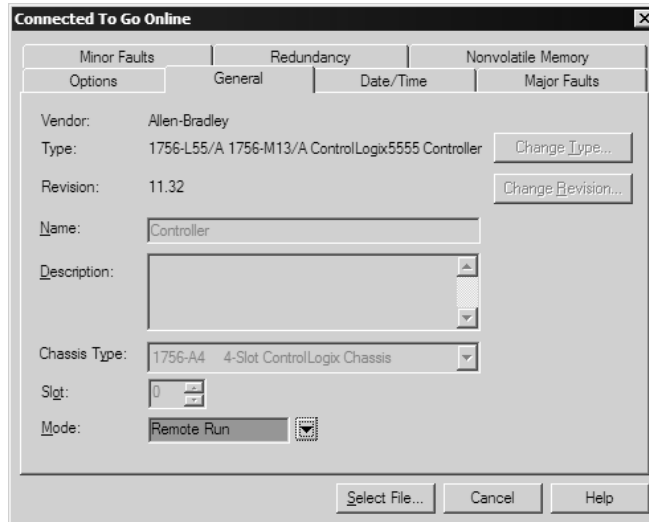

- 6 Select the sample ladder logic file for your firmware version.

To open the sample program

- 1 On the Connected to Go Online dialog box, click the Select File button.
- 2 Choose the sample program file that matches your firmware version, and then click the Select button.
- 3 RSLogix will load the sample program.

Choose the Controller Type

The sample application may have been developed with a different ControlLogix processor model and rack size than the one you are using. If you are using a different model of the ControlLogix processor, you must configure the sample program to use the correct processor model.

To choose the Controller Type

- 1 In the Controller Organization list, select the folder "Controller MVI56", and then click the right mouse button to open a shortcut menu.

- On the shortcut menu, choose **Properties**. This action opens the Controller Properties dialog box.

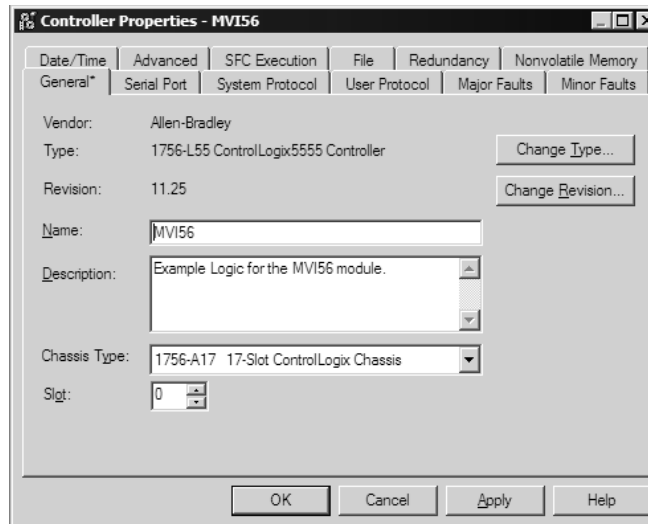

- Click the **Change Controller** button. This action opens the Change Controller dialog box.

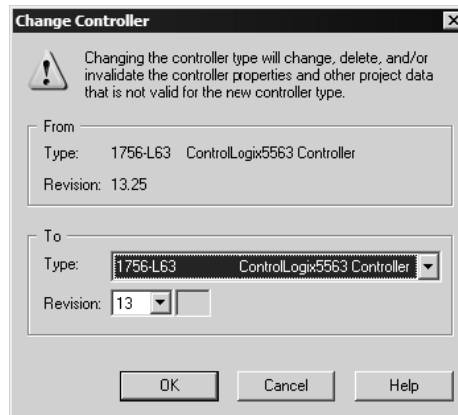

- Open the Type: dropdown list, and then select your ControlLogix controller.
- Select the correct firmware revision for your controller, if necessary.
- Click OK to save your changes and return to the previous window.

Select the Slot Number for the Module

The sample application is for a module installed in Slot 1 in a ControlLogix rack. The ladder logic uses the slot number to identify the module. If you are installing the module in a different slot, you must update the ladder logic so that program tags and variables are correct, and do not conflict with other modules in the rack.

To change the slot number

- 1 In the Controller Organization list, select the module [1] 1756-MODULE MVI56, and then click the right mouse button to open a shortcut menu.
- 2 On the shortcut menu, choose **Properties**. This action opens the Module Properties dialog box.

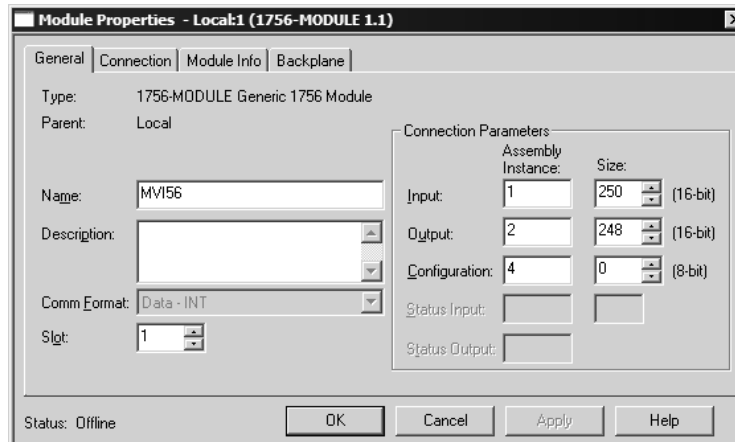

- 3 In the **Slot:** field, use the spinners on the right side of the field to select the slot number where the module will reside in the rack, and then click OK.

RSLogix will automatically apply the slot number change to all tags, variables and ladder logic rungs that use the MVI56-WA-PWP slot number for computation.

1.8 Download the Sample Program to the Processor

Note: The key switch on the front of the ControlLogix module must be in the REM position.

To download the sample program from RSLogix 5000 to the ControlLogix processor

- 1 If you are not already online to the processor, open the Communications menu, and then choose Download. RSLogix will establish communication with the processor.
- 2 When communication is established, RSLogix will open a confirmation dialog box. Click the Download button to transfer the sample program to the processor.

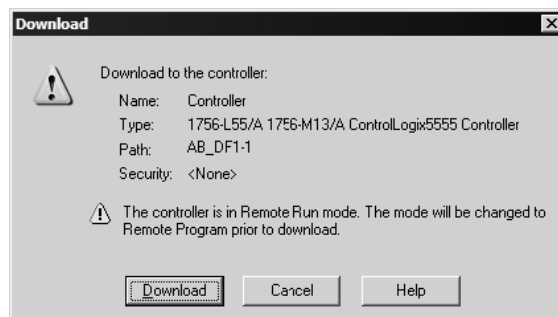

- 3 RSLogix will compile the program and transfer it to the processor. This process may take a few minutes.
- 4 When the download is complete, RSLogix will open another confirmation dialog box. Click OK to switch the processor from Program mode to Run mode.

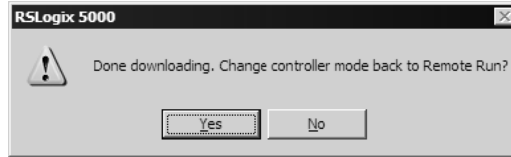

Note: If you receive an error message during these steps, refer to your RSLogix documentation to interpret and correct the error.

1.8.1 Configuring RSLinx

If RSLogix is unable to establish communication with the processor, follow these steps:

- 1 Open RSLinx.
- 2 Open the Communications menu, and choose Configure Drivers.

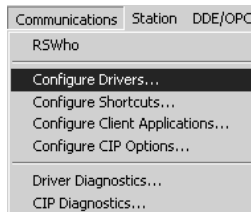

This action opens the Configure Drivers dialog box.

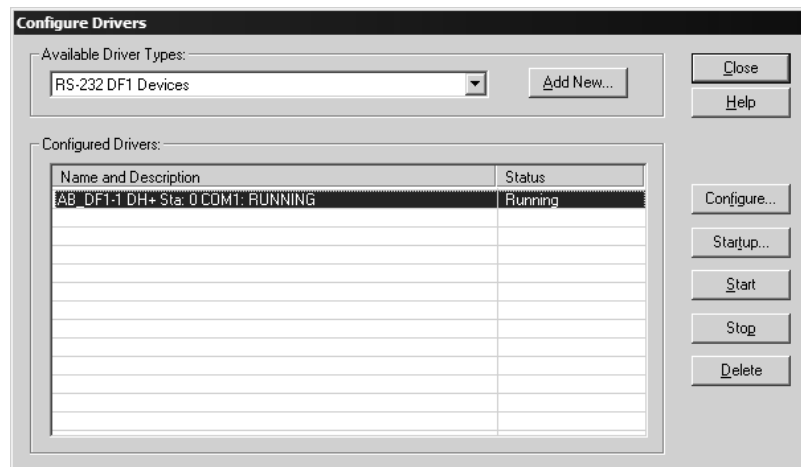

Note: If the list of configured drivers is blank, you must first choose and configure a driver from the Available Driver Types list. The recommended driver type to choose for serial communication with the processor is "RS-232 DF1 Devices".

- 3 Click to select the driver, and then click Configure. This action opens the Configure Allen-Bradley DF1 Communications Device dialog box.



- 4 Click the Auto-Configure button. RSLinx will attempt to configure your serial port to work with the selected driver.
- 5 When you see the message "Auto Configuration Successful", click the OK button to dismiss the dialog box.

Note: If the auto-configuration procedure fails, verify that the cables are connected correctly between the processor and the serial port on your computer, and then try again. If you are still unable to auto-configure the port, refer to your RSLinx documentation for further troubleshooting steps.

2 Configuring the MVI56-WA-PWP Module

In This Chapter

❖ ProSoft Configuration Builder	21
❖ [Backplane Configuration]	27
❖ [Radio Configuration].....	28
❖ [Radio SNTP Client]	29
❖ [RADIO PWP Exchanges]	31
❖ [Radio PWP Multicast Group List]	35
❖ Radio Ethernet Configuration (WATTCP).....	36

Because the task of configuring the PWP Wireless network can be complicated, ProSoft Technology has provided a configuration tool called ProSoft Configuration Builder (PCB) that will help you with the following tasks:

- Creating a configuration project
- Setting module parameters
- Configuring the wireless network
- Copying the project to the module.

The following topics of this chapter explain each task step-by-step.

Tip: A sample configuration file (PPF file) is provided on the ProSoft Solutions CD-ROM that contains the configuration allowing the MVI56-WA-PWP module and a ProLinx 6104-WA-PDPM module to communicate wirelessly.

2.1 ProSoft Configuration Builder

ProSoft Configuration Builder (PCB) provides a quick and easy way to manage module configuration files customized to meet your application needs. PCB is not only a powerful solution for new configuration files, but also allows you to import information from previously installed (known working) configurations to new projects.

2.1.1 Set Up the Project

To begin, start ProSoft Configuration Builder. If you have used other Windows configuration tools before, you will find the screen layout familiar. ProSoft Configuration Builder's window consists of a tree view on the left, an information pane and a configuration pane on the right side of the window. When you first start ProSoft Configuration Builder, the tree view consists of folders for Default Project and Default Location, with a Default Module in the Default Location folder. The following illustration shows the ProSoft Configuration Builder window with a new project.

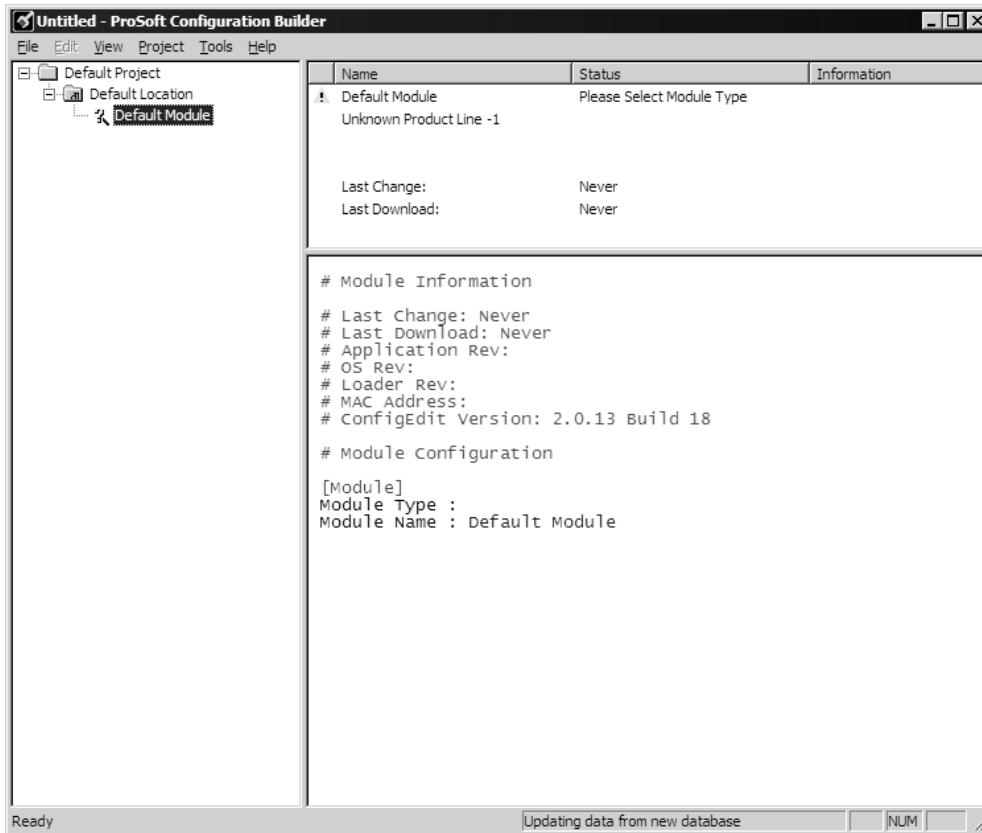

Your first task is to add the MVI56-WA-PWP module to the project.

- 1 Use the mouse to select "Default Module" in the tree view, and then click the right mouse button to open a shortcut menu.

- 2 On the shortcut menu, choose "Choose Module Type". This action opens the Choose Module Type dialog box.

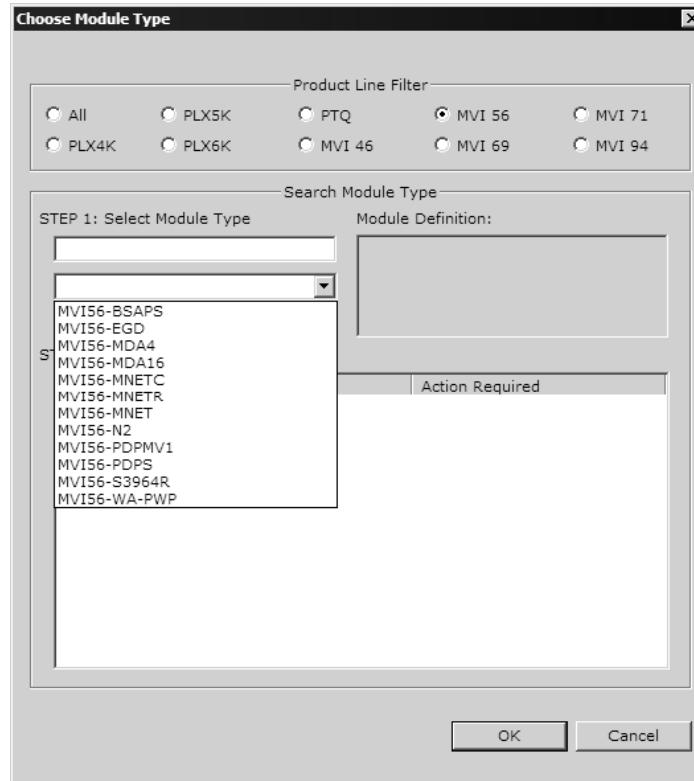

- 3 In the Product Line Filter area of the dialog box, select MVI56. In the Select Module Type dropdown list, select MVI56-WA-PWP, and then click OK to save your settings and return to the ProSoft Configuration Builder window.

The next task is to set the module parameters.

Adding a Project

To add a project to an existing project file:

- 1 Select the Default Project icon.
- 2 Choose Project from the Project menu, then choose Add Project. A new project folder appears.

Adding a Module

To add a module to your project:

- 1 Double-click the Default Module icon to open the Choose Module Type dialog box.

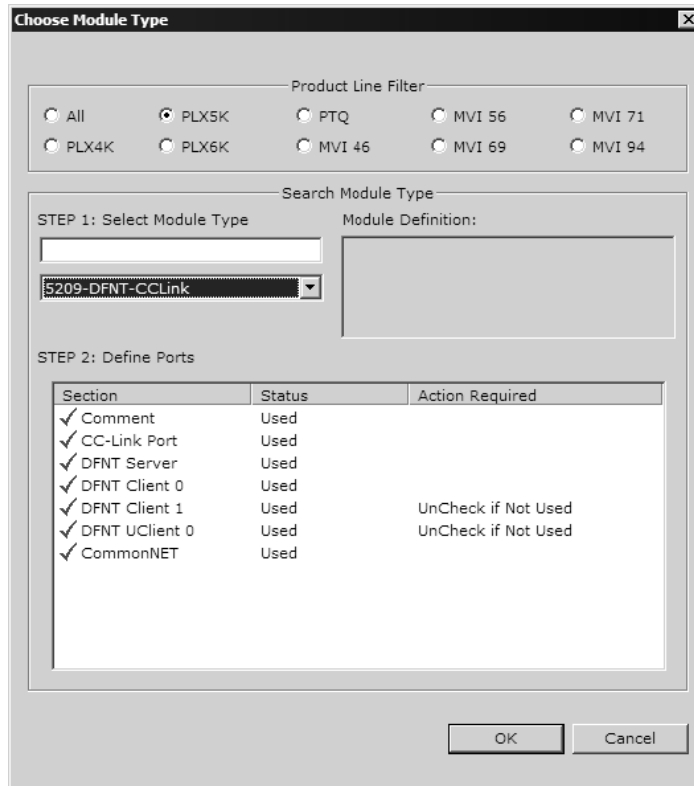

- 2 On the Choose Module Type dialog box, select the module type.
Or
 - 1 Open the Project menu and choose Location.
 - 2 On the Location menu, choose Add Module.

To add a module to a different location:

- 1 Right-click the Location folder and choose Add Module. A new module icon appears.
Or
 - 1 Select the Location icon.
 - 2 From the Project menu, select Location, then select Add Module.

2.1.2 Set Module Parameters

Notice that the contents of the information pane and the configuration pane changed when you added the MVI56-WA-PWP module to the project.





At this time, you may wish to rename the "Default Project" and "Default Location" folders in the tree view.

To rename an object:

- 1 Select the object, and then click the right mouse button to open a shortcut menu. From the shortcut menu, choose Rename.
- 2 Type the name to assign to the object.
- 3 Click away from the object to save the new name.



Module Entries

To configure module parameters

- 1 Click on the plus sign next to the icon  Comment to expand module information.
- 2 Double-click the  Module Comment icon to open the Edit dialog box.
- 3 To edit a parameter, select the parameter in the left pane and make your changes in the right pane.
- 4 Click OK to save your changes.

Comment Entries

To add comments to your configuration file:

- 1 Click the plus sign to the left of the  Comment icon to expand the Module Comments.
- 2 Double-click the  Module Comment icon. The Edit - Module Comment dialog appears.

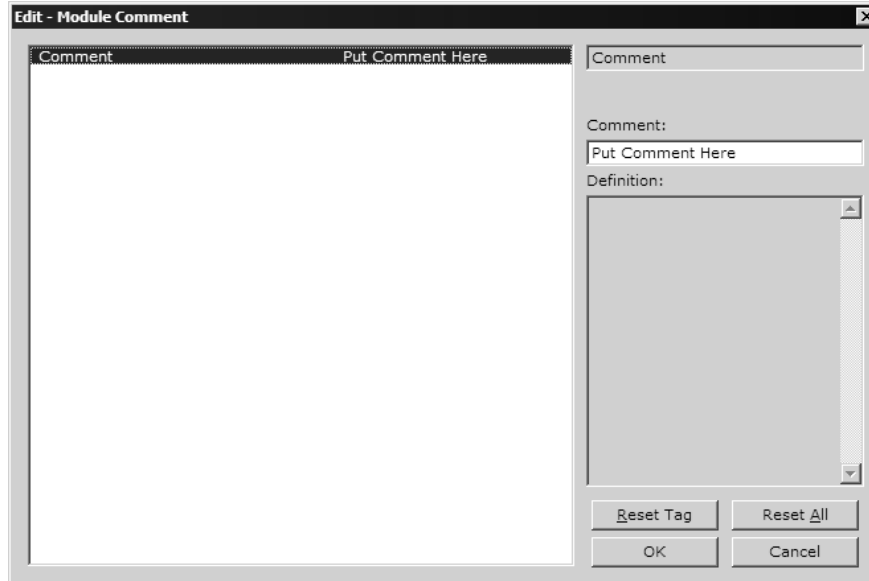

- 3 Enter your comment and click OK to save your changes.

Printing a Configuration File

To print a configuration file:

- 1 Select the Module icon, and then click the right mouse button to open a shortcut menu.
- 2 On the shortcut menu, choose View Configuration. This action opens the View Configuration window.
- 3 On the View Configuration window, open the File menu, and choose Print. This action opens the Print dialog box.
- 4 On the Print dialog box, choose the printer to use from the dropdown list, select printing options, and then click OK.

2.2 [Backplane Configuration]

This section designates database addresses for input and output on the module and on the processor, and identifies the method of failure for the communications for the module if the processor is not in run mode.

The following example shows a sample [Backplane Configuration] section:

```
[Backplane Configuration]
Read Register Start   :    0 # DB start location in module for data moved from
                        # module to processor.
Read Register Count   : 1000 # Number of registers to move from module to
                        # processor.
Write Register Start  : 1000 # DB start location in module for data moved from
                        # processor to module.
Write Register Count  : 1000 # Number of registers to move from processor to
                        # module
Failure Flag Count    :    0 #
```

2.2.1 Read Register Start

Range 0 to 3999

This parameter specifies the starting register in the module where data will be transferred from the module to the processor. Valid range for this parameter is 0 to 3999.

2.2.2 Read Register Count

Range 0 to 3999

This parameter specifies the number of registers to be transferred from the module to the processor. Valid entry for this parameter is 0 to 3999.

2.2.3 Write Register Start

0 to 3999

This parameter specifies the starting register in the module where the data will be transferred from the processor to the module.

2.2.4 Write Register Count

Range 0 to 3999

This parameter specifies the number of registers to transfer from the processor to the module. Valid entry for this parameter is 0 to 3999.

2.2.5 Failure Flag Count

0 through 65535

This parameter specifies the number of successive transfer errors that must occur before the communication ports are shut down. If the parameter is set to 0, the communication ports will continue to operate under all conditions. If the value is set larger than 0 (1 to 65535), communications will cease if the specified number of failures occur.

2.3 [Radio Configuration]

The Radio Configuration section contains basic configuration parameters for the radio. The following settings configure the radio.

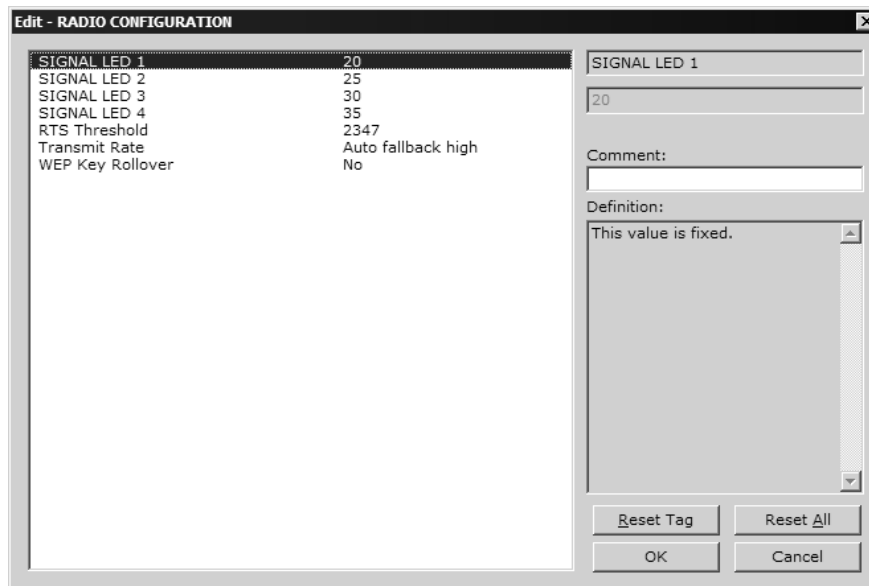

2.3.1 Signal LED 1, 2, 3, 4

SIGNAL LED 1: 20

SIGNAL LED 2: 25

SIGNAL LED 3: 30

SIGNAL LED 4: 35

The Signal LEDs on the front of the module indicate the current quality (signal strength minus noise) of the radio signal. The parameter for each LED determines the signal strength level at which the LED will illuminate.

After the module powers up, all signal LEDs will be off. When the module establishes a connection to another module, the signal LEDs will display the strength of the radio signal.

If the radio communication is dropped when in ad-hoc mode (for example, if the other radio is turned off), the signal strength LEDs will flash periodically at a rate of approximately 10 seconds on and one second off.

2.3.2 *Transmit Rate*

This parameter defines the data rate(s) for transmission of directed messages. Possible values are outlined in the following table.

Value	Definition
1	Fixed 1 Mbit (1)
2	Fixed 2 Mbit (2)
3	Auto fallback high (11, 5.5, 2, 1)
4	Fixed medium rate (5.5)
5	Fixed high rate (11)
6	Auto fallback standard (2, 1)
7	Auto fallback medium (5.5, 2, 1)

Important: For Multicast mode, use transmit rates of 1 or 2 Mbps for best results.

2.3.3 *WEP Key Rollover*

Yes or No

WEP (Wireless Encryption Protocol) is an encryption method that allows devices on a wireless network to transmit data securely.

This parameter interacts with the WATTCP parameter "Enable Encryption", and the values for WEP Keys 1 through 4. When the WEP Key Rollover parameter is enabled, the module will randomly change the WEP key.

2.4 [Radio SNTP Client]

The [Radio SNTP Client] section specifies the parameters for the Simple Network Time Protocol (SNTP) client provided with the protocol driver. This client is required in order to keep the driver's internal clock set correctly. This version of the driver supports the unicast implementation of the SNTP Revision 3 and stratum between 1 and 14.

The module can be configured to periodically synchronize its clock with a remote SNTP server. Approximately every 6 minutes the module sends 10 consecutive requests to the remote SNTP client (at approximately 6 second intervals). You can check these requests and responses by looking at the SNTP Client Configuration Menu (press the N key at the Configuration/Debug Main Menu). If the module receives a valid response from the SNTP server, the computations value will be also be incremented. After 10 consecutive successful requests and responses, the module will synchronize its internal clock (an average is performed based on all 10 responses for better accuracy). The Time Set Cnt value is incremented every time the clock is synchronized.

After the synchronization is performed, the time valid register is set to Yes. If the module cannot connect to the remote SNTP server after 3 consecutive attempts, the time valid register is set to No. You can also configure the GMT settings to use, and the database address where the date and time information can be copied.

The following parameters set up the SNTP client:

```
[RADIO SNTP CLIENT]
NTP SERVER IP ADDRESS      : 0.0.0.0 # IP address for NIST, Boulder, Colorado
TIME_ZONE                  :      8 # Number of hours from GMT (-11 to +11)
USE DAYLIGHT SAVINGS TIME :     No # Yes or No
DATABASE REGISTER         :   3000 # database word location where to store
                               # time (-1=ignore).
```

The database register parameter defines a database register where the SNTP time and date values are copied. It occupies 4 words as follows:

Word Offset	Description
0 and 1	Date and time in Unix format (long integer)
2 and 3	Microseconds (long integer)

2.4.1 NTP Server IP Address

Enter in dotted notation

This parameter sets the IP address of the NTP server to contact for time acquisition. Select an NTP server with the greatest accuracy that is available all the time from your network. Set this IP address to 0.0.0.0 to disable SNTP server requests.

2.4.2 Time Zone

-11 to 11

This parameter sets the time zone offset from UTC. Positive values are for time zones west of UTC, and negative values are for time zones east of UTC. Set this value to 0 to use UTC in the module.

2.4.3 Use Daylight Savings Time

Yes or No

This parameter specifies if daylight savings time will be used in the time computation.

2.4.4 Database Register

-1 or 0 to 3992 as an even value

This parameter specifies if the NTP time computed by the driver is to be placed into the module's database. If a value of -1 is specified, the time will not be placed into the database. If the value is between 0 and 3992, the time will be placed in the database. The first 4 bytes represent the seconds since 1/1/1970, and the second 4 bytes represent the number of microseconds. An even value should be used for the register value in order for the data to be stored correctly.

2.5 [RADIO PWP Exchanges]

In order to interface the module with PWP devices, you must construct an exchange list. The exchanges specify messages that will be produced or consumed at a user-defined frequency using the module's internal database. Messages can be broadcast to all nodes on the network, sent to a multicast group on the network or associated with a single node on the network. Up to 100 exchanges can be defined for the driver. Up to 680 word registers can be produced or consumed in a single exchange.

The [RADIO PWP Exchanges] section defines the messages that will be produced and consumed by the driver. The UDP protocol on the IP network is used to transport these over Ethernet between all the PWP devices.

For the exchanges to operate correctly, the other PWP devices must be configured and correctly set up. The primary reason for user problems with the module is failure to provide devices that are correctly configured. Before trying to connect the module to the network, the remote device must be able to communicate with ProSoft Configuration Builder. You must understand and document all parameters.

2.5.1 Exch Type

Producer: exchange will be producing data to other stations

Consumer: exchange will be consuming data from another station

The Exchange Type field defines the type of exchange used in the exchange as either producer or consumer. Producer exchanges (P) are generated by the driver using the module's database. Consumer exchanges (C) are those received from other WA-PWP devices with the data in the message being placed in the module's database.

2.5.2 Cast Type

When the Exchange Type is **Producer**, the cast type field determines if the exchange is a unicast ('U' = point-to-point) exchange, multicast ('M'=multicast group) or a broadcast ('B' = all nodes) exchange.

- Producer Unicast - produce message to another station
- Producer Multicast - produce message to a group of stations. In order to use this option you need to configure the same Multicast IP address used in the exchange also at the [RADIO PWP MULTICAST GROUP LIST] section.

Important: For Multicast mode, use transmit rates (page 29) of 1 or 2 for best results.

- Producer Broadcast - produce message to all stations (set exchange IP address to 255.255.255.255)

When the Exchange Type is **Consumer**, the cast type field determines how the local database area associated to this exchange will be updated in case an RF Error (timeout) occurs.

- Consumer No DB Change on RF Error
- Consumer Set DB to -1 On RF Error

- Consumer Set DB to 0 On RF Error
- Consumer Set DB to 1 On RF Error

2.5.3 DB Reg

The DB Register field defines the starting database register in the module where data sourced (produced data) or placed (consumed data) is determined by the value entered in the DB Reg column. This parameter can have a value of 0 to 3999. The validity of the entry is dependent on the number of registers (Reg Count) to be produced or consumed. The sum of the two values cannot exceed 4000, as this would be outside the range of the module's database.

2.5.4 Reg Count

Number of database registers to transfer/accept in message.

2.5.5 Swap Code

0, 1, 2 or 3

The Swap Code field sets byte and word swapping of data produced or consumed. Swapping of words and/or bytes in the message may be required for different protocol and operating systems as their representation of multi-byte values may not be the same as that of the WA-PWP protocol.

Swap Code	Description
0	None - No Change is made in the byte ordering (1234 = 1234)
1	Words - The words are swapped (1234=3412)
2	Words & Bytes - The words are swapped then the bytes in each word are swapped (1234=4321)
3	Bytes - The bytes in each word are swapped (1234=2143)

2.5.6 P/C Time

The P/C Time field defines the number of milliseconds between productions of the exchange data and for consumed exchanges. This value defines the number of milliseconds to wait for a produced exchanged before a timeout condition is present.

- For a producer exchange it defines the number of milliseconds between consecutive producer exchanges.
- For a consumer exchange it defines the number of milliseconds to wait for a produced message before a timeout error is set. It is suggested to use a value at least four times greater than the value used in the producer exchange.

For consumed messages, set this value to approximately 4 times the produced time of the exchange on the other device. This will prevent the exchange from constantly timing out on a busy network. If this parameter is set to zero, the message will not be produced.

A zero value for a consumed message indicates that the exchange will never timeout. The zero value can be used for exchanges that will interface with the command service port (7937) to handle data read and write requests from another device.

2.5.7 IP Address

The IP Address field should be set to the IP address of destination device (produced data) or source device (consumed data).

Producer Exchange IP address: If the cast type is set to 'U' for a produced exchange, the address should be set to IP address of the specific node to receive (consume) the data. If the cast type is set to 'B' for produced data, set the IP to either a network (255.255.255.255) or subnet (192.168.0.255) broadcast address. If the cast type is set to 'M' for produced data, set the IP address to a valid multicast address.

Multicast Address Assignments

Important: Use Multicast whenever the module produces data to at least two other modules. Using Unicast for these applications can cause data transmission delay when at least one of the consumer modules is powered down.

Multicast group addresses 224.0.7.1 to 224.0.7.32 are reserved. The module does not place this limit for messages but the user should consider using the reserved group addresses. The following table shows the relationship between multicast group parameters and IP addresses. Refer to Underlying Protocol Requirements and Constraints for more detailed information on IP and UDP addresses.

Parameter	IP Address
Group 1	224.0.7.1
Group 2	224.0.7.2
...	...
Group 32	224.0.7.32

Important: For Multicast mode, use transmit rates (page 29) of 1 or 2 for best results.

Consumer Exchange IP address: For consumed messages both Broadcast and Multicast type messages should be set to the IP address of the producer generating the specific exchange. The combination of the IP address and the exchange ID uniquely identify the exchange to the system.

2.5.8 Exch ID

1 to 16383

The Exch ID field defines the Exchange ID for this message, and must be unique for each node. For produced exchanges, the module IP address and the entered exchange ID uniquely define the exchange to the network. Defined consumer exchanges use the IP address in the message along with this exchange ID to determine which exchange to associate with the message. The parameters defined in the exchange then determine how much data is present in the message and where to place it into the module's internal database.

2.5.9 CS Major, CS Minor

This is an optional functionality that can be used to prevent unexpected results when changes are performed to existing producer and consumer exchanges.

The Configuration Signature consists of two one-byte integer value (CS Major and CS Minor). The CS Major must be equal for both Producer and Consumer exchanges. The CS Minor reflects backward compatible modifications made to an exchange (for example: adding registers to the producer exchange count). Truncating data within an exchange is not backward compatible and requires a change in the major number.

The purpose of the Configuration Signature (CS) is to guarantee that the produced exchange will contain data in a format expected by a consumer module. Therefore it prevents the consumer module to process received data if it is not compatible because of later modifications.

Whenever a consumer module receives an exchange message, it will look for a configured consumer exchange that contains the same Exchange ID. If it finds a matching consumer exchange it will compare the Configuration Signature for validation.

If the exchange is not validated then the data will not be consumed.

Because this functionality is optional, the modules will exchange data even if the Configuration Signature validation is disabled. To disable this functionality, configure all exchanges with both CS Major and CS Minor values equal to zero.

The following rules are used by the consumer module to validate an exchange based on its Configuration Signature:

Rules for CS Validation

An exchange will be considered valid if at least one of the following conditions is true:

- Producer CS Major and CS Minor are both equal to 0
- Consumer CS Major and CS Minor are both equal to 0
- Producer CS Major is equal than Consumer CS Major AND Producer CS Minor is greater or equal than Consumer CS Minor

The following table contains some examples that will help you to understand the consumer criteria to validate received exchanges based on the Configuration Signature:

Producer CS Major	Producer CS Minor	Consumer CS Major	Consumer CS Minor	Will Data be Consumed?	Comment
0	0	0	0	Yes	Same CS value of 0.0 (Major.Minor) validates the exchange
0	0	1	2	Yes	Producer CS value of 0.0 (Major.Minor) validates the exchange
1	2	0	0	Yes	Consumer CS value of 0.0 (Major.Minor) validates the exchange
1	2	1	2	Yes	Same CS value (1.2) validates the exchange
2	2	1	2	No	CS Major mismatch - exchange is not validated

Producer CS Major	Producer CS Minor	Consumer CS Major	Consumer CS Minor	Will Data be Consumed?	Comment
1	2	2	2	No	CS Major mismatch - exchange is not validated
1	2	1	1	Yes	Same CS Major and Consumer CS Minor is less than Producer CS Minor - exchange is validated
1	2	1	3	No	Same CS Major but Consumer CS Minor is greater than Producer CS Minor - exchange is not validated

2.5.10 Radio PWP Exchange Command List Example

The following is an example section from the [PWP Exchanges] section:

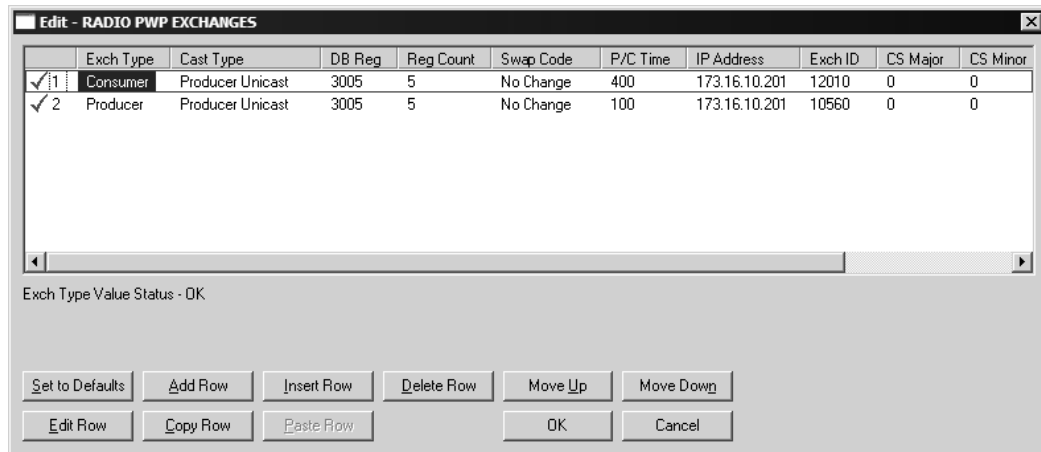

2.6 [Radio PWP Multicast Group List]

This section contains the list of multicast group addresses the PWP server should process (consumer messages for this server produced on other units). This list may contain up to 16 IP addresses. The reserved group addresses for the PWP protocol are 224.0.7.1 to 224.0.7.32. The module will support other group addresses than this data set.

Important: Use Multicast whenever the module produces data to at least two other modules. Using Unicast for these applications can cause data transmission delay when at least one of the consumer modules is powered down.

2.7 Radio Ethernet Configuration (WATTCP)

The Radio Ethernet Configuration is used to configure ethernet and wireless communication information.

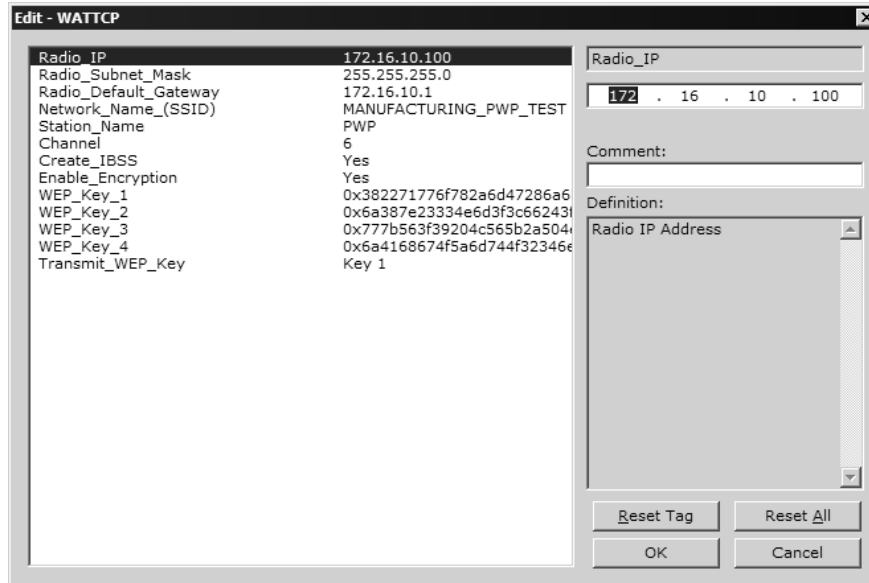

2.7.1 Radio_IP

Default: 192.168.0.100

The IP address of the module to be used in wireless communication.

2.7.2 Radio_Subnet_Mask

Default: 255.255.255.0

The subnet mask to be used in wireless communication.

2.7.3 Radio_Default_Gateway

Default: 172.16.10.1

The default gateway to be used in wireless communication.

2.7.4 Network_Name_(SSID)

Valid Values: any character in the range of "A to Z", "a to z" and "0 to 9" where:

- The value "ANY" enables your station to connect to any IEEE 802.11 compliant network.
- A "user-defined name" allows your station to connect to a specific network only. This value should match the value as set for the Access Point in your wireless network.

The SSID used when connecting to a wireless network used by an Access Point or Ad hoc station. Value can be alphanumeric string with a maximum of 32 ASCII characters that identifies the network to which you would like to connect your wireless station.

You should configure all modules that will be exchanging data to use the same SSID.

2.7.5 Create_IBSS

The following options are applicable during the module's power-up initialization in its attempt to connect to available devices.

Yes

- a Connect Infrastructure (ESS) when Access Point IS available.
- b Connect Ad-hoc (IBSS) when Access Point NOT available.

No

- a Connect Infrastructure (ESS) when Access Point IS available.
- b Will NOT connect Ad-hoc (IBSS) when Access Point NOT available.

2.7.6 Station_Name

An alphanumeric string with a maximum of 32 ASCII characters that will identify your station on the wireless network.

Valid Values: any character in the range of "A to Z", "a to z" and "0 to 9".

2.7.7 Channel

0 to 14 (Default 10)

Channel this module will use on the wireless network. Used for creating Ad hoc link. Channels 1 to 14 are available. FCC allows for channels 1 to 11, ETSI (Europe) channels 1 to 13, France channels 1 to 9, Japan channels 1 to 14. Contact ProSoft Technology for country approval list.

All modules for the same network should use the same channel number.

2.7.8 Enable_Encryption

Y = Yes. Enable WEP encryption

N = No. Do not enable WEP encryption

(Default = N)

Enables or Disables WEP encryption.

When this parameter is enabled, you can:

- Select up to four key for decrypting data received via the wireless interface.
- Select one Transmit key for encrypting data that will be transmitted via the wireless interface.

If you decide to enable encryption, please note that all stations will be configured with identical WEP key values.

2.7.9 WEP_Key_1 to WEP_Key_4

5-character ASCII key or 10-digit hexadecimal key for 64-bit encryption.

13-character ASCII key or 26-digit hexadecimal key for 128-bit encryption.

Identifies one of the four keys your station device can use to decrypt data received via its wireless interface. 64-bit or 128-bit encryption is selected by the number of characters.

The key value is case-sensitive. Hexadecimal values must be preceded by "0x". All wireless clients and access points should be configured with identical key values.

Note: Use only WEP Key 1 when communicating with an RLX-IH access point/repeater.

2.7.10 Transmit_WEP_Key

Selects which WEP key to use for encryption.

Note: If the WEP Key Rollover parameter is enabled, then the module will use a random WEP key out of the four provided, overriding any value specified in this parameter.

3 Verify Radio Communications

In This Chapter

- ❖ Save and Download the Configuration File to the MVI56-WA-PWP 39
- ❖ Save and Download the Configuration File to the 6104-WA-PDPM 41
- ❖ Verify Data Exchange..... 42

This chapter shows how to use the sample configuration file MVI56-WA-PWP_to_6104-WA-PDPM.ppf, on the ProSoft Solutions CD, to communicate wirelessly between two modules:

- MVI56-WA-PWP
- ProLinx 6104-WA-PDPM

This sample configuration is just one example of the many ProSoft Wireless Protocol modules in the inRAX, ProLinx and ProTalk product lines that are capable of communicating wirelessly with each other.

3.1 Save and Download the Configuration File to the MVI56-WA-PWP

With the module securely mounted, connect your PC to the **Configuration/Debug** port using an RJ45-DB-9 Serial Adapter Cable and a Null Modem Cable.

- 1 Attach both cables as shown.
- 2 Insert the RJ45 cable connector into the Configuration/Debug port of the module.

- 3 Attach the other end to the serial port on your PC.

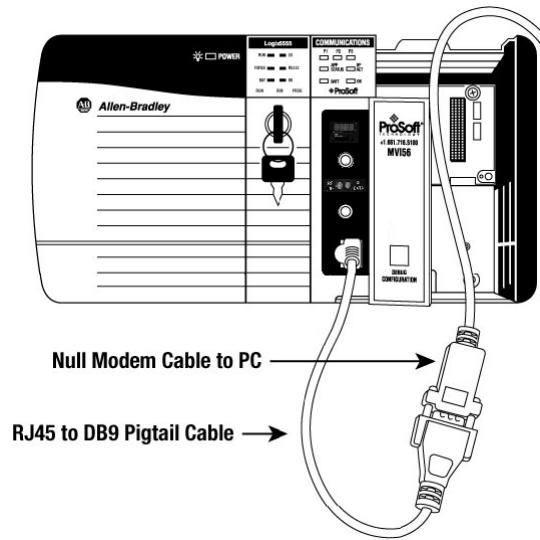

- 4 Choose **File / Save As...** and save the .PPF file to a location on your hard drive.

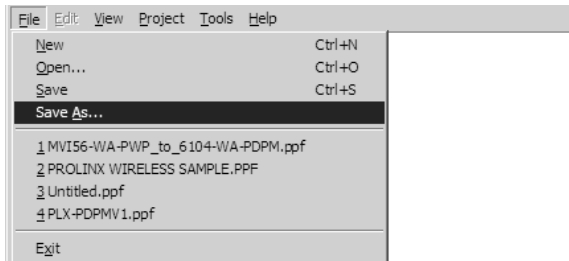

- 5 Right-click on MVI56-WA-PWP and select **Download from PC to Device**.

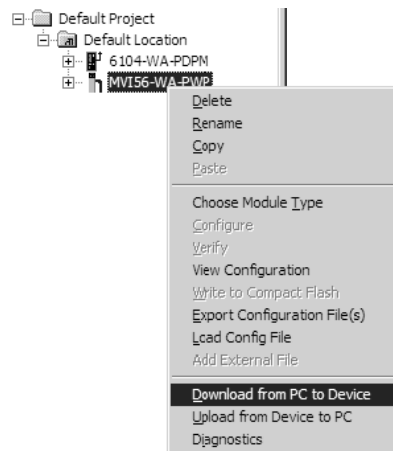

- 6 Select the appropriate COM port and click the **Download** button.

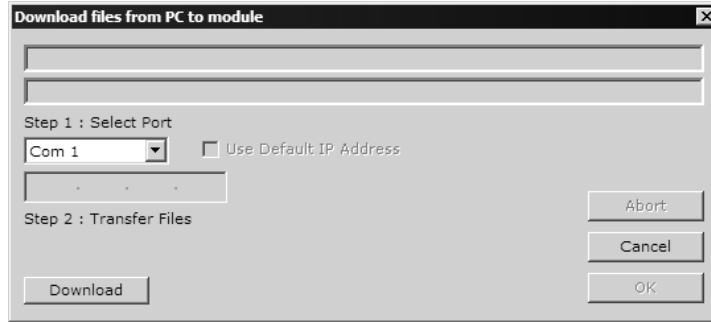

- 7 The download is complete when the OK button becomes active. When the download is completed, click the **OK** button.

3.2 Save and Download the Configuration File to the 6104-WA-PDPM

- 1 Connect your PC to the DEBUG port of the 6104-WA-PDPM module. Apply power to the module if you have not already done so.

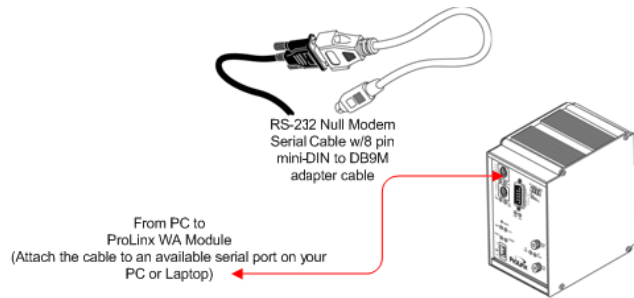

- 2 Right-click on 6104-WA-PDPM and select **Download from PC to Device**.



- 3 Select the appropriate COM port and click the **Download** button.

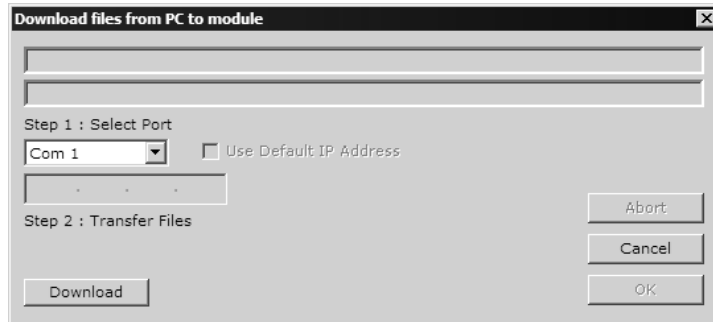

The download is complete when the OK button becomes active. When the download is complete, click **OK**.

3.3 Verify Data Exchange

Run Diagnostics Using ProSoft Configuration Builder

- 1 Connect the cable to the Debug Port of the MVI56-WA-PWP module. Ensure that power is applied to both modules.

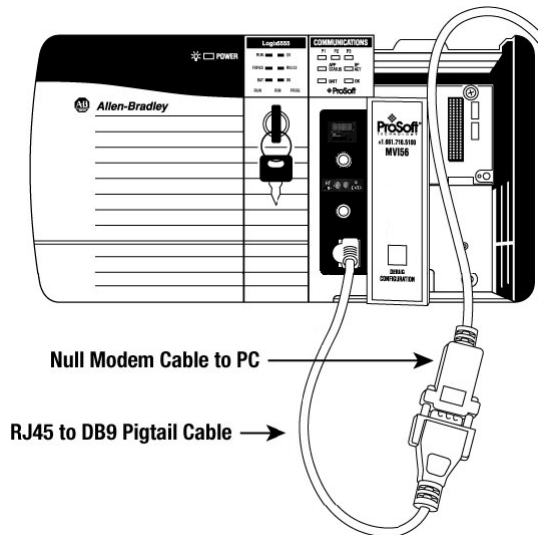

- 2 Right-click on MVI56-WA-PWP and select Diagnostics.

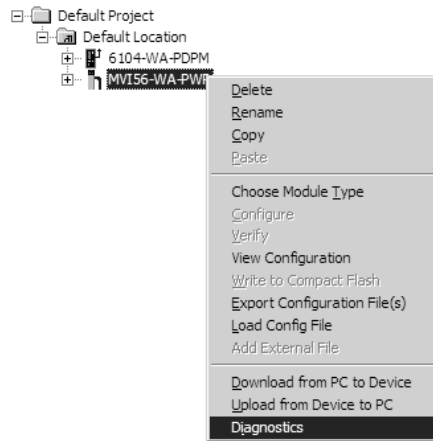

- 3 Select the appropriate Com port



- 4 Press "?" to display the Diagnostic menu.
- 5 Press "D" to display the Database menu.
- 6 Press "3" to show database registers beginning at 3000.

- 7 Press the "S" key to refresh the database values. The circled values in the example should change each time you press the "S" key indicating that data is being passed between modules. If these values do not change, contact ProSoft Technical Support.

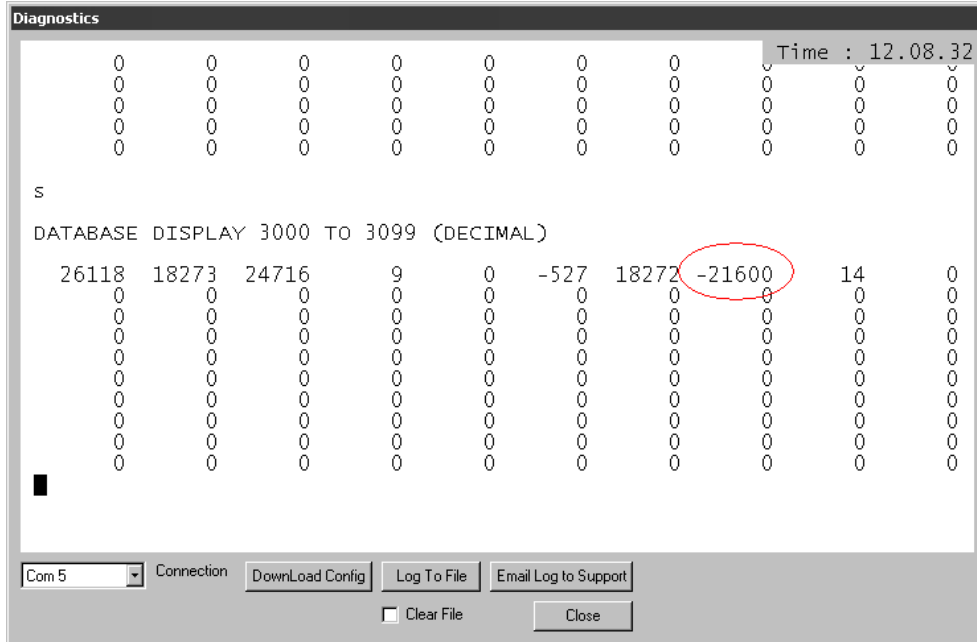

The data shown represents clock values that are being passed wirelessly from the 6104-WA-PDPM. The values are stored in five registers beginning with register 3005.

4 Diagnostics and Troubleshooting

In This Chapter

- ❖ Reading Status Data from the Module 45
- ❖ LED Status Indicators..... 58

The module provides information on diagnostics and troubleshooting in the following forms:

- Status data values are transferred from the module to the processor.
- Data contained in the module can be viewed through the Configuration/Debug port attached to a terminal emulator.
- LED status indicators on the front of the module provide information on the module's status.

4.1 Reading Status Data from the Module

The MVI56-WA-PWP module returns General Status Data and C/P Status Data blocks that can be used to determine the module's operating status. This data can be located in the module's database at registers at the location specified in the configuration. This data also available to the ControlLogix processor with each read block. Refer to Backplane Data Transfer (page 67) for information on the contents of this block.

4.1.1 Required Hardware

You can connect directly from your computer's serial port to the serial port on the module to view configuration information, perform maintenance, and send (upload) or receive (download) configuration files.

ProSoft Technology recommends the following minimum hardware to connect your computer to the module:

- 80486 based processor (Pentium preferred)
- 1 megabyte of memory
- At least one UART hardware-based serial communications port available. USB-based virtual UART systems (USB to serial port adapters) often do not function reliably, especially during binary file transfers, such as when uploading/downloading configuration files or module firmware upgrades.
- A null modem serial cable.

4.1.2 The Configuration/Debug Menu

The Configuration and Debug menu for this module is arranged as a tree structure, with the Main Menu at the top of the tree, and one or more sub-menus for each menu command. The first menu you see when you connect to the module is the Main menu.

Because this is a text-based menu system, you enter commands by typing the command letter from your computer keyboard in the diagnostic window in ProSoft Configuration Builder (PCB). The module does not respond to mouse movements or clicks. The command executes as soon as you press the command letter — you do not need to press **[Enter]**. When you type a command letter, a new screen will be displayed in your terminal application.

Using the Diagnostic Window in ProSoft Configuration Builder

To connect to the module's Configuration/Debug serial port:

- 1 Start PCB program with the application file to be tested. Right click over the module icon.

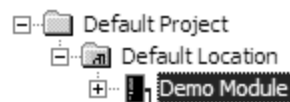

- 2 On the shortcut menu, choose Diagnostics.

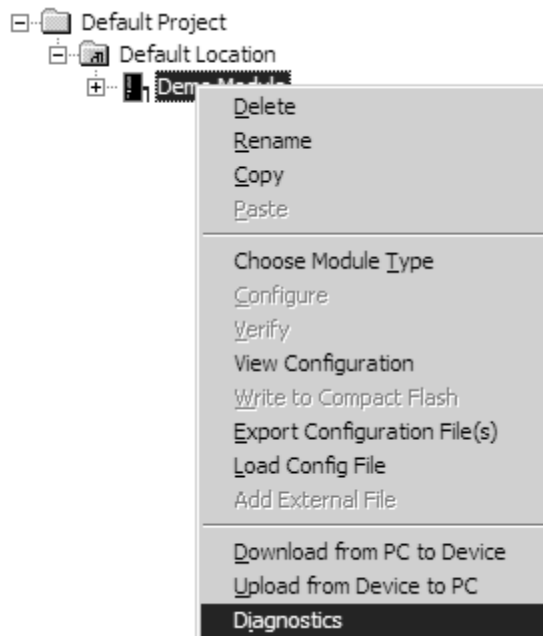

- 3 This action opens the Diagnostics dialog box. Press "?" to display the Main Menu.

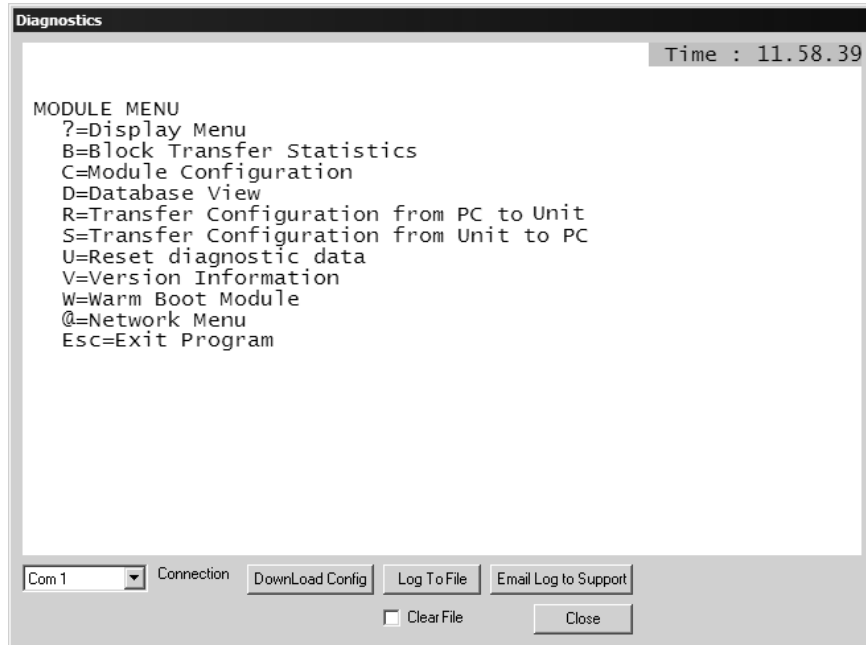

Important: The illustrations of configuration/debug menus in this section are intended as a general guide, and may not exactly match the configuration/debug menus in your own module.

If there is no response from the module, follow these steps:

- 1 Verify that the null modem cable is connected properly between your computer's serial port and the module. A regular serial cable will not work.
- 2 On computers with more than one serial port, verify that your communication program is connected to the same port that is connected to the module.

If you are still not able to establish a connection, contact ProSoft Technology for assistance.

Navigation

All of the sub-menus for this module contain commands to redisplay the menu or return to the previous menu. You can always return from a sub-menu to the next higher menu by pressing **[M]** on your keyboard.

The organization of the menu structure is represented in simplified form in the following illustration:

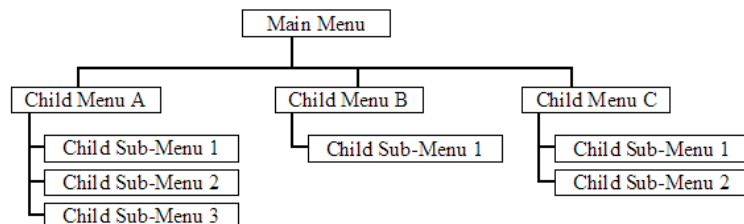

The remainder of this section shows you the menus available for this module, and briefly discusses the commands available to you.

Keystrokes

The keyboard commands on these menus are almost always non-case sensitive. You can enter most commands in lower case or capital letters.

The menus use a few special characters ([**?**], [**-**], [**+**], [**@**]) that must be entered exactly as shown. Some of these characters will require you to use the [**Shift**], [**Ctrl**] or [**Alt**] keys to enter them correctly. For example, on US English keyboards, enter the [**?**] command as [**Shift**]/[**/**].

Also, take care to distinguish capital letter [**I**] from lower case letter [**i**] (L) and number [**1**]; likewise for capital letter [**O**] and number [**0**]. Although these characters look nearly the same on the screen, they perform different actions on the module.

4.1.3 Main Menu

When you first connect to the module from your computer, your terminal screen will be blank. To activate the main menu, press the [**?**] key on your computer's keyboard. If the module is connected properly, the following menu will appear on your terminal screen:

Caution: Some of the commands available to you from this menu are designed for advanced debugging and system testing only, and can cause the module to stop communicating with the processor or with other devices, resulting in potential data loss or other failures. Only use these commands if you are specifically directed to do so by ProSoft Technology Technical Support staff. Some of these command keys are not listed on the menu, but are active nevertheless. Please be careful when pressing keys so that you do not accidentally execute an unwanted command.

```
WIRELESS COMMUNICATION MODULE MENU
?=Display Menu
B=Profibus Configuration
C=Module Configuration
D=Database View
P=Profibus Menu
R=Radio Menu
S=Transfer Configuration from Unit to PC
U=Reset status
V=Version Information
W=warm Boot Module
Y=PWP Menu
Z=SNTP Status
@=Network Menu
%=Map Data Menu
Esc=Exit Program
```

Redisplaying the Menu

Press [**?**] to display the current menu. Use this command when you are looking at a screen of data, and want to view the menu choices available to you.

Viewing Module Configuration

Press **[C]** to view the Module Configuration screen.

Use this command to display the current configuration and statistics for the module.

Opening the Database Menu

Press **[D]** to open the Database View menu. Use this menu command to view the current contents of the module's database.

Opening the Radio Menu

Press **[R]** to open the Radio menu. Use this command to view configuration and status for the module's onboard radio.

Transferring the Configuration File from MVI56 module to PC

Press **[S]** to receive (download) the configuration file from the module to your PC.

Press **[Y]** to confirm the file transfer, and then follow the instructions on the terminal screen to complete the file transfer process.

After the file has been successfully downloaded, you can open and edit the file to change the module's configuration.

Resetting diagnostic data

Press **[U]** to reset the status counters for the client and/or servers in the module.

Viewing Version Information

Press **[V]** to view Version information for the module.

Use this command to view the current version of the software for the module, as well as other important values. You may be asked to provide this information when calling for technical support on the product.

Values at the bottom of the display are important in determining module operation. The Program Scan Counter value is incremented each time a module's program cycle is complete.

Tip: Repeat this command at one-second intervals to determine the frequency of program execution.

Warm Booting the Module

Caution: Some of the commands available to you from this menu are designed for advanced debugging and system testing only, and can cause the module to stop communicating with the processor or with other devices, resulting in potential data loss or other failures. Only use these commands if you are specifically directed to do so by ProSoft Technology Technical Support staff. Some of these command keys are not listed on the menu, but are active nevertheless. Please be careful when pressing keys so that you do not accidentally execute an unwanted command.

Press **[W]** from the Main Menu to warm boot (restart) the module. This command will cause the program to exit and reload, refreshing configuration parameters that must be set on program initialization. Only use this command if you must force the module to re-boot.

Opening the PWP Menu

Press **[Y]** to open the PWP Menu. Use this command to view configuration and status for the PWP protocol.

Viewing SNTP Status

Press **[N]** to view configuration information about the SNTP client.

```
SNTP CLIENT CONFIGURATION:
NTP SERVER IP : 0.0.0.0
DB REGISTER   : -1
TIME ZONE     : 0           USE DST       : No
TIME VALID    : No
REQUESTS      : 0           RESPONSES  : 0
COMPUTATIONS  : 0           TIME SET CNT : 0
TIMEOUT ERRS  : 0
```

Refer to SNTP Support for more information on configuring and using this function.

Opening the Network Menu

Press **[@]** to open the network menu. The network menu allows you to send, receive and view the WATTCP.CFG file that contains the IP, gateway and other network specification information. You can find more information about the commands on this menu in the Network Menu (page 54) section.

Opening the Map Data Menu

Press **[%]** to open the Map Data menu. Use this command to view settings and status of the database map.

Exiting the Program

Caution: Some of the commands available to you from this menu are designed for advanced debugging and system testing only, and can cause the module to stop communicating with the processor or with other devices, resulting in potential data loss or other failures. Only use these commands if you are specifically directed to do so by ProSoft Technology Technical Support staff. Some of these command keys are not listed on the menu, but are active nevertheless. Please be careful when pressing keys so that you do not accidentally execute an unwanted command.

Press **[Esc]** to restart the module and force all drivers to be loaded. The module will use the configuration stored in the module's Flash ROM to configure the module.

4.1.4 Database View Menu

Press **[D]** from the Main Menu to open the Database View menu. Use this menu command to view the current contents of the module's database. Press **[?]** to view a list of commands available on this menu.

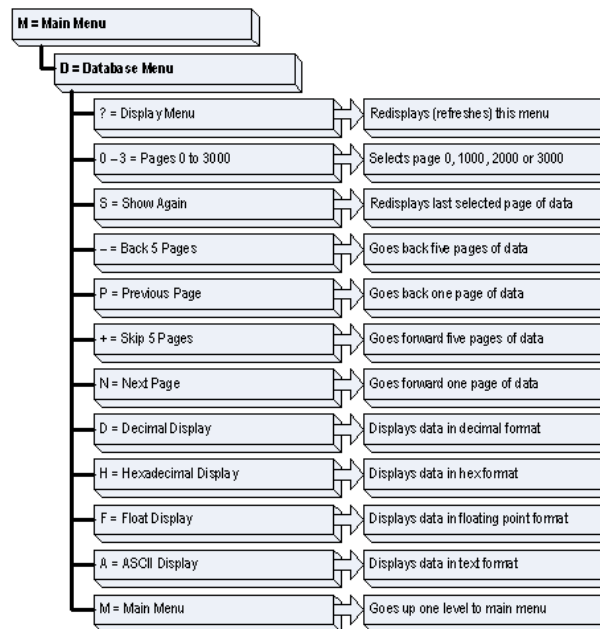

Viewing Register Pages

To view sets of register pages, use the keys described below:

Command	Description
[0]	Display registers 0 to 99
[1]	Display registers 1000 to 1099
[2]	Display registers 2000 to 2099

And so on. The total number of register pages available to view depends on your module's configuration.

Displaying the Current Page of Registers Again

DATABASE DISPLAY 0 TO 99 <DECIMAL>									
100	101	102	4	5	6	7	8	9	10
11	12	13	14	15	16	0	0	0	0
0	0	0	0	0	0	0	0	0	0
0	0	0	0	0	0	0	0	0	0
0	0	0	0	0	0	0	0	0	0
0	0	0	0	0	0	0	0	0	0
0	0	0	0	0	0	0	0	0	0
0	0	0	0	0	0	0	0	0	0
0	0	0	0	0	0	0	0	0	0
0	0	0	0	0	0	0	0	0	0
0	0	0	0	0	0	0	0	0	0

This screen displays the current page of 100 registers in the database.

Moving Back Through 5 Pages of Registers

Press **[-]** from the Database View menu to skip back to the previous 500 registers of data.

Viewing the Previous 100 Registers of Data

Press **[P]** from the Database View menu to display the previous 100 registers of data.

Skipping 500 Registers of Data

Hold down **[Shift]** and press **[=]** to skip forward to the next 500 registers of data.

Viewing the Next 100 Registers of Data

Press **[N]** from the Database View menu to select and display the next 100 registers of data.

Viewing Data in Decimal Format

Press **[D]** to display the data on the current page in decimal format.

Viewing Data in Hexadecimal Format

Press **[H]** to display the data on the current page in hexadecimal format.

Viewing Data in Floating Point Format

Press **[F]** from the Database View menu. Use this command to display the data on the current page in floating point format. The program assumes that the values are aligned on even register boundaries. If floating-point values are not aligned as such, they are not displayed properly.

Viewing Data in ASCII (Text) Format

Press **[A]** to display the data on the current page in ASCII format. This is useful for regions of the database that contain ASCII data.

Returning to the Main Menu

Press **[M]** to return to the Main Menu.

4.1.5 Radio Menu

Press **[R]** to open the Radio menu. Use this command to view configuration and status for the module's onboard radio.

```
RADIO MENU
C=Configuration
S=Status
1=Constant Radio Status Update
M=Return to Main Menu
```

Viewing Radio Configuration

Press **[C]** to view radio configuration. Use this command to view the port type, channel, data length and other radio configuration settings.

```
DRADIO STATIC CONFIGURATION:
Port Type      : 1          Own MAC Address: 00:10:C6:47:79:68
Own Channel    : 10         Own SSID:
Max Data Len   : 1508      Own Name: New
Encryption     : 0         Authentication  : 1
TX Rate Ctrl   : 3         WEP Key Rollover: No
LED Levels     : 20 - 25 - 30 - 35
```

Viewing Radio Status

Press **[S]** to view the current operational status of the radio. Use this command to view connection and signal status, packets and bytes transferred, signal quality and errors.

```
DRADIO DRIVER STATUS:
Port Status = Connected IBSS SSID = NetworkWA
Transmit Rate = 11 MB Signal Quality = 83 dB
Signal Level = -19 dBm Noise Level = -102 dBm
PacketsIn = 12082 PacketsOut = 23737
BytesIn = 1932496 BytesOut = 3796798
ErrorsIn = 1 ErrorsOut = 559
PacketsDropped = 0 Channel # = 10
```

Continuously Monitoring Radio Status

Press **[1]** to monitor radio status continuously. Use this command to view the signal strength and noise level for the radio in real time.

```
Radio Monitor Enabled. Press any key to exit.  
Q= 48 dB SL= -46 dBm NL= -94 dBm  
Q= 48 dB SL= -46 dBm NL= -94 dBm  
Q= 49 dB SL= -46 dBm NL= -95 dBm  
Q= 50 dB SL= -45 dBm NL= -95 dBm  
Q= 50 dB SL= -45 dBm NL= -95 dBm  
Q= 49 dB SL= -46 dBm NL= -95 dBm  
Q= 49 dB SL= -46 dBm NL= -95 dBm  
Q= 49 dB SL= -46 dBm NL= -95 dBm
```

Important: When in continuous radio monitor mode, program execution will slow down. Only use this tool during a trouble-shooting session. Before disconnecting from the Config/Debug port, please be sure to press a key to disable the radio status monitor. This action will allow the module to resume its normal operating mode.

Returning to the Main Menu

Press **[M]** to return to the Main Menu.

4.1.6 Network Menu

The network menu allows you to send, receive and view the WATTCP.CFG file that contains the IP and gateway addresses, and other network specification information.

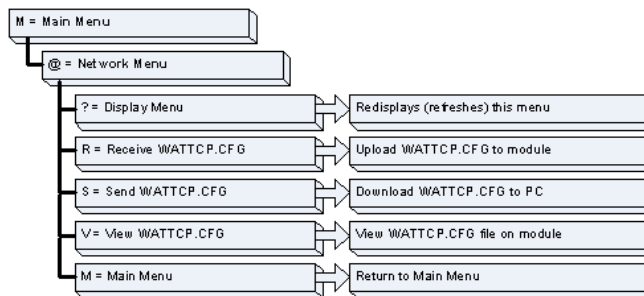

Transferring WATTCP.CFG to the module

Press **[R]** to transfer a new WATTCP.CFG file from the PC to the module. Use this command to change the network configuration for the module (for example, the module's IP address).

Press **[Y]** to confirm the file transfer, and then follow the instructions on the terminal screen to complete the file transfer process.

Transferring WATTCP.CFG to the PC

Press **[S]** to transfer the WATTCP.CFG file from the module to your PC.

Press **[Y]** to confirm the file transfer, and then follow the instructions on the terminal screen to complete the file transfer process.

After the file has been successfully transferred, you can open and edit the file to change the module's network configuration.

Viewing the WATTCP.CFG file on the module

Press **[V]** to view the module's WATTCP.CFG file. Use this command to confirm the module's current network settings.

```

Network Menu Selected
WATTCP.CFG FILE:
# ProLinx Communication Gateways, Inc.
#
# Default private class 3 address
my_ip=192.168.0.135
# Default class 3 network mask
netmask=255.255.255.0
# The gateway I wish to use
gateway=192.168.0.1
#
#Parameters used by the ProLinx Communication Gateways, Inc. module
#Local_Domain_Name=mycompany.com
#Password=PASSWORD

```

Returning to the Main Menu

Press **[M]** to return to the Main Menu.

4.1.7 PWP Menu

Press **[Y]** to open the PWP Menu. Use this command to view configuration and status for the PWP protocol.

```

RADIO PWP MENU
C=Producer/Consumer List Menu
G=Multicast Group List
S=Status Data Menu
?=Display Menu
M=Exit Menu

```

Opening the Producer/Consumer List Menu

Press **[C]** to open the Producer/Consumer List menu. Use this command to view the status of producers and consumers currently communicating on the network.

RADIO PWP PRODUCER/CONSUMER LIST 0 TO 9									
P/C	U/B	ADDR	REG_CNT	SWP	PROD_TIME	IP ADDRESS	EX_ID	CFG_VER	
P	M	200	32	0	100	224.0.7.1	10	0.0	
C	M	0	32	0	100	224.0.7.1	11	0.0	
P	M	200	32	0	100	224.0.7.2	30	0.0	
C	M	32	32	0	100	224.0.7.2	31	0.0	

Viewing the Multicast Group List

Press **[G]** to view the Multicast Group List. Use this command to see a list of IP addresses in the radio's configured multicast group.

```
RADIO MULTICAST GROUP LIST (Count=2):  
E0000701 224.0.7.1  
E0000702 224.0.7.2
```

Opening the Status Data Menu

Press **[S]** to open the Radio PWP Producer/Consumer Status List menu. Use this command to view communication status for each of the configured producers and consumers.

```
Status Data Menu Selected  
RADIO PWP PRODUCER/CONSUMER STATUS 0 TO 9  
S P MSG_COUNT MISS_COUNT REF_COUNT INVALID TM_SYNC SHORT LONG PROTO  
1 2 14604 0 0 0 0 0 0 0  
2 0 0 0 172126 0 0 0 0 0  
1 2 14604 0 0 0 0 0 0 0  
2 0 0 0 172126 0 0 0 0 0
```

Redisplaying the Menu

Press **[?]** to display the current menu. Use this command when you are looking at a screen of data, and want to view the menu choices available to you.

Returning to the Main Menu

Press **[M]** to return to the Main Menu.

4.1.8 Radio PWP Producer/Consumer List Menu

Press **[S]** to open the Radio PWP Producer/Consumer Status List menu. Use this command to view communication status for each of the configured producers and consumers.

```
RADIO PWP PRODUCER/CONSUMER STATUS MENU  
?=Display Menu  
S=Show Again  
-=Back 2 Pages  
P=Previous Page  
+=Skip 2 Pages  
N=Next Page  
?=Display Menu  
M=Return to RADIO PWP Main Menu
```

Redisplaying the Menu

Press **[?]** to display the current menu. Use this command when you are looking at a screen of data, and want to view the menu choices available to you.

Redisplaying the Current Page

Press **[S]** to display the current page of data.

Going Back Two Pages of Data

Press **[-]** from the Database View menu to skip back to the previous 200 registers of data.

Viewing the Previous Page of Data

Press **[P]** to display the previous page of data.

Going Ahead Two Pages of Data

Hold down **[Shift]** and press **[=]** to skip forward to the next 200 registers of data.

Viewing the Next Page of Data

Press **[N]** to display the next page of data.

Returning to the Previous Menu

Press **[M]** to return to the Previous Menu.

4.2 LED Status Indicators

The LEDs indicate the module's operating status as follows:

Module	Color	Status	Indication
CFG	Green	On	Data is being transferred between the module and a remote terminal using the Configuration/Debug port.
		Off	No data is being transferred on the Configuration/Debug port.
P1	Green	On	Not used in this application
		Off	Not used in this application
P2	Green	On	Not used in this application
		Off	Not used in this application
APP	Amber	Off	The MVI56-WA-PWP is working normally.
		On	The MVI56-WA-PWP module program has recognized a communication error on one of its ports.
BP ACT	Amber	On	The LED is on when the module is performing a write operation on the backplane.
		Off	The LED is off when the module is performing a read operation on the backplane. Under normal operation, the LED should blink rapidly on and off.
OK	Red/ Green	Off	The card is not receiving any power and is not securely plugged into the rack.
		Green	The module is operating normally.
		Red	The program has detected an error or is being configured. If the LED remains red for over 10 seconds, the program has probably halted. Remove the card from the rack and re-insert the card to restart the module's program.
BAT	Red	Off	The battery voltage is OK and functioning.
		On	The battery voltage is low or battery is not present. Allow battery to charge by keeping module plugged into rack for 24 hours. If BAT LED still does not go off, contact ProSoft Technology, as this is not a user serviceable item.

If the APP, BP ACT and OK LEDs blink at a rate of every one-second, this indicates a serious problem with the module. Call ProSoft Technology support to arrange for repairs.

4.2.1 RF LEDs

If the RF Signal Level LEDs are continuously asserted these will indicate the current quality level signal while the module is connected in either ad-hoc or infrastructure mode:

SIGNAL LED 1: 20

SIGNAL LED 2: 25

SIGNAL LED 3: 30

SIGNAL LED 4: 35

If the RF Signal Level LEDs are asserted for approximately 10 seconds and off for approximately 1 seconds it means that the module lost communication with the previously connected ad-hoc remote station (the asserted LEDs indicate the last measured quality level before disconnection).

If the RF Signal Level LEDs are off it means that either:

- 1 The module was initialized and has not established connection to any station
or
- 2 The module was disconnected from a previously connected Access Point.

RF Link: (Green) asserted continuously if module is:

- Connected ad-hoc
- Connected Infrastructure (ESS)
- Out of range Infrastructure (ESS)

If the RF Link LED is asserted for approximately 10 seconds and off for approximately 1 seconds it means that either:

- 1 The module was initialized and have not connected to any stations
- 2 The module lost communication with the previously connected ad-hoc remote station.

RF Data: (Green) Asserted when data is received or transmitted to the module

4.2.2 Clearing a Fault Condition

Typically, if the OK LED on the front of the module turns red for more than ten seconds, a hardware problem has been detected in the module, or the program has exited.

To clear the condition, follow these steps:

- 1 Turn off power to the rack
- 2 Remove the card from the rack
- 3 Verify that all jumpers are set correctly
- 4 If the module requires a Compact Flash card, verify that the card is installed correctly
- 5 Re-insert the card in the rack and turn the power back on
- 6 Verify the configuration data being transferred to the module from the ControlLogix processor.

If the module's OK LED does not turn green, verify that the module is inserted completely into the rack. If this does not cure the problem, contact ProSoft Technology Support.

4.2.3 Troubleshooting

Use the following troubleshooting steps if you encounter problems when the module is powered up. If these steps do not resolve your problem, please contact ProSoft Technology Technical Support.

Processor Errors

Problem Description	Steps to take
Processor Fault	Verify that the module is plugged into the slot that has been configured for the module. Verify that the slot in the rack configuration has been set up correctly in the ladder logic.
Processor I/O LED flashes	This indicates a problem with backplane communications. Verify that all modules in the rack are configured in the ladder logic.

Module Errors

Problem Description	Steps to take
BP ACT LED remains off or blinks slowly	This indicates that backplane transfer operations are failing. Connect to the module's Configuration/Debug port to check this. To establish backplane communications, verify the following items: <ul style="list-style-type: none">▪ The processor is in Run mode.▪ The backplane driver is loaded in the module.▪ The module is configured for read and write block data transfer.▪ The ladder logic handles all read and write block situations.▪ The module is configured in the processor.
OK LED remains red	The program has halted or a critical error has occurred. Connect to the Configuration/Debug port to see if the module is running. If the program has halted, turn off power to the rack, remove the card from the rack and re-insert the card in the rack, and then restore power to the rack.

5 Reference

In This Chapter

❖ Product Specifications	61
❖ Functional Overview	63
❖ Jumper and Wiring Settings	76
❖ Exchange Configuration Form	80

5.1 Product Specifications

The In-Chassis Wireless Communication Module creates a powerful wireless connection between devices located remotely, and the ControlLogix processor. The efficient but powerful PWP protocol allows data exchange in one-to-one or one-to-many wireless scenarios.

ProSoft Wireless Protocol (PWP) offers versatility where a mix of control devices requires cooperation with each other. This involves sharing of information across the applications regardless of device or network type, often at high speed. Wireless bandwidth utilization is optimized by using efficient communication methods. The protocol supports Unicast, Broadcast and Multicast group messaging. The protocol is efficient because each device on the wireless network can produce these types of messages and each device determines which of these messages to consume.

5.1.1 Functional Specifications

The ProSoft Wireless Protocol allows one controller to produce or send an area of its memory onto a network at a specified rate. It also allows another controller to consume or receive this data. Each data message contains a data sample, or snapshot, of a specific portion of the producing node's memory. Data messages are uniquely identified so that consuming nodes can relate the incoming data with a specific configuration (known as an exchange) which describes key characteristics of the data sample. A node can contain a number of these exchanges, so that it may be both a consumer of some exchanges and a producer of others at the same time.

Periodic Data Services provide an efficient mechanism which allows the repeated transmission of a set of variables from a controller which *produces* data, to one or more controllers which *consume* the data. Significant features of the Periodic Data Service include:

- A single request for data from a consumer controller can cause data packets to be sent repetitively from the producer.
- The set of data variables to be sent periodically can be pre-defined so that the controller starts sending the data as soon as it is initialized.

- Data can be sent to the specific node that requested it, or simultaneously to a group of nodes.
- Periodic Data Services utilize a low level protocol (UDP/IP) which requires less overhead than fully acknowledged stream oriented protocols.

Includes ProSoft Configuration Builder (PSW-PCB) configuration software.

General Radio Specifications

Specification	Value
Frequency	2.4 GHz band (2400 to 2483.5 MHz)*
Wireless medium	DSSS - Direct Sequence Spread Spectrum (802.11 b)
Output power	32 mW (15 dBm)
Channel data rates	11, 5.5, 2, 1 Mbps
Channels - user selectable	11 - North America 13 - Europe** 14 - Japan
Security	PWP + WEP 64/128 Encryption with WEP key rollover management
Antenna Ports	Two RP-SMA connectors, automatic antenna diversity
Bit Error Rate (BER)	Better than 10 ⁻⁵

Range / Transmit Rate	High Speed 11 Mbps	Medium Speed 5.5 Mbps	Standard Speed 2 Mbps	Low Speed 1 Mbps
Open Office Environment	160m (525 ft.)	270 m (885 ft.)	400 m (1300 ft.)	550 m (1750 ft)
Semi-Open Office Environment	50 m (165 ft.)	70 m (230 ft.)	90 m (300 ft.)	115 m (375 ft.)
Closed Office	25 m (80 ft.)	35 m (115 ft.)	40 m (130 ft.)	50 m (165 ft)
Receiver Sensitivity	-83 dBm	-87 dBm	-91 dBm	-94 dBm

General range guidelines (actual results may vary)

* Varies with country regulation

** Some European countries such as France allow fewer channels

Specification	Description
Form Factor:	Single Slot 1756 Chassis Compatible Local or Remote Rack
Backplane Current Load	800 mA @ 5 V 3mA @ 24V DC
Operating Temperature	0 to 60°C (32 to 140°F)
Storage Temperature	-40 to 85°C (-40 to 185°F)
Shock:	30g Operational 50g non-operational Vibration: 5 g from 10 to 150 Hz
Relative Humidity	5% to 95% (non-condensing)
LED Indicators:	Module Status Backplane Transfer Status Application Status Serial Activity
Shipped with Unit	RJ45 to DB-9M cables for each port 6-foot RS-232 configuration cable
Debug/Configuration port (CFG)	
CFG Port (CFG)	RJ45 (DB-9M with supplied cable) RS-232 only No hardware handshaking

5.2 Functional Overview

The ProSoft Wireless Protocol (PWP) can be used to interface many different protocols with PWP devices. PWP provides a means by which one controller produces or sends an area of its memory onto a network at a specified rate. It also describes the means for another controller to consume or receive this data. Each data message contains a data sample, or snap-shot, of a specific portion of the producing node's memory. Data messages are uniquely identified so that consuming nodes can relate the incoming data with a specific configuration (known as an exchange) which describes key characteristics of the data sample. A node can contain a number of these exchanges, so that it may be both a consumer of some exchanges and a producer of others at the same time.

Periodic Data Services provide an efficient mechanism which allows the repeated transmission of a set of variables from a controller which produces data, to one or more controllers which consume the data. Significant features of the Periodic Data Service include:

- A single request for data from a consumer controller can cause data packets to be sent repetitively from the producer.
- The set of data variables to be sent periodically can be pre-defined so that the controller starts sending the data as soon as it is initialized.
- Data can be sent to the specific node that requested it, or simultaneously to a group of nodes.
- Periodic Data Services utilize a low level protocol (UDP/IP) which requires less overhead than fully acknowledged stream oriented protocols.

5.2.1 Underlying Protocol Requirements and Constraints

PWP protocol messages are classified as either command or data messages. PWP has been designed to operate on a message based, connectionless network transport layer, such as the internet UDP/IP protocol. Each protocol message is sent to a specific network access point (UDP port) on the destination node(s). Command messages can be used to monitor and control the operation of PWP on the destination node. Command messages usually derived from SCADA systems are not currently supported. Data messages are individually configured to send a sample of data at a fixed periodic rate. Each data message that a node sends or receives is associated with a specific identifier, which uniquely defines the configuration of the data sample. This configuration is referred to as an exchange. PWP allows the configuration of exchanges which are sent to a single destination address (IP Unicast addressing), a group of addresses (IP Multicast addressing), or to all PWP nodes (IP Broadcast addressing). An assigned set of 32 IP Multicast addresses has been defined for use by applications requiring the transmission of data exchanges to a group of nodes. The following tables show the defined network parameters for PWP.

Assigned UDP Network Ports

Parameter	UDP Port
Command Port	7937. (1F01H)
Data Port	18246. (4746H)

Multicast Address Assignments

Parameter	IP Address
Group 1	224.0.7.1
Group 2	224.0.7.2
...	...
Group 32	224.0.7.32

PWP provides a means by which one controller produces or sends an area of its memory onto a network at a specified rate. It also describes the means for another controller to consume or receive this data. Each data message contains a data sample, or snap-shot, of a specific portion of the producing node's memory. Data messages are uniquely identified so that consuming nodes can relate the incoming data with a specific configuration (known as an exchange) which describes key characteristics of the data sample. A controller can contain a number of these exchanges, so that it may be both a consumer of some exchanges, and a producer of others at the same time.

The user defines the data to be produced and consumed in a configuration file downloaded to the module. The command service is limited to responding to requests from other units. The module will not initiate port 7937 commands. The driver interfaces with a common internal database in the module. This permits the sharing of data across many different types of networks. The following illustration shows the functionality of the PWP driver when interfaced with serial communication based and 802.11b wireless networks:

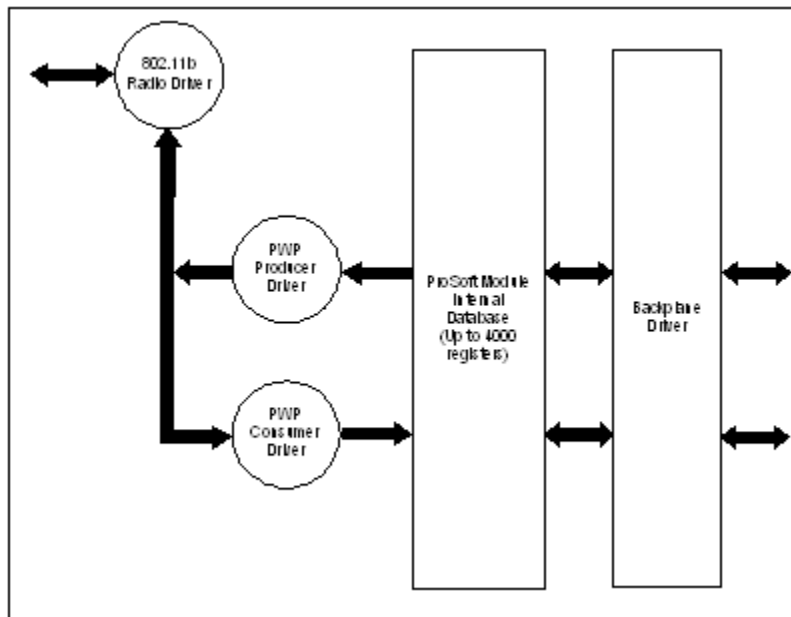

In order to use these functions, an exchange must first exist in the module's exchange list defining the database and register count. If the production/consumption time is set to zero, the exchange will never be produced or consumed and will only be valid for command processing. These functions should be used for data that is not time critical and does not require periodic updating. The maximum length of the message is limited to 1360 bytes.

5.2.2 PWP Producer

The PWP driver will generate produced data as defined in the user configuration exchange list. This data is derived from the module's internal database and is produced at the set interval defined in the exchange list. This data can be broadcast to all nodes, sent to a specific multicast group or sent to a specific node on the network. Up to 700 database registers can be transferred in a single produced message. Therefore, to transfer the whole database would only require 6 messages (4000 word registers in the module's database).

Central to the functionality of the module is the internal database. This database is shared between all the drivers in the module and is used as a conduit to pass information from one device on one network to one or more devices on another network. This permits data from devices on one communication port to be viewed and controlled by devices on another port.

The producer functionality provided in the PWP driver transfers portions of the module's database to other PWP nodes on the network. The following diagram describes the flow of data between the Producer, the internal database and the remote Consumer device:

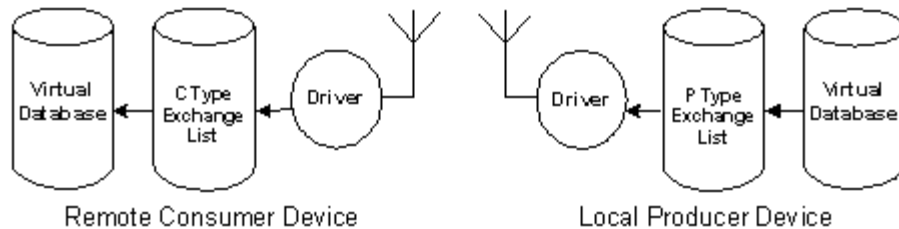

5.2.3 PWP Consumer

The PWP driver will consume data as defined in the user configuration exchange list. This data is derived from other nodes on the network and is placed in the module's internal database. If a consumer exchange is not received at the specified timeout, the driver will update the status of the exchange. When the driver again receives the exchange, the status will be updated. Exchanges received by the consumer driver that are not defined in the exchange list will be discarded. Up to 700 words of data can be consumed in a single message. Therefore, to fill the whole database with values would only require 6 exchanges (4000 word registers in the module's database).

The consumer functionality provided in the PWP driver transfers data from other nodes on the network into the module's database. The following diagram describes the flow of data between the Consumer, the internal database and the remote Producer device:

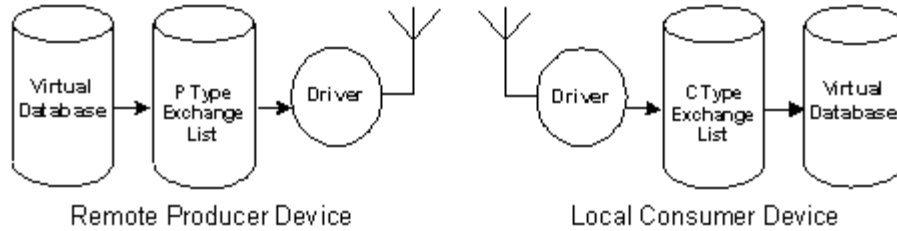

5.2.4 General Concepts

The following topics describe several concepts that are important for understanding the operation of the MVI56-WA-PWP module.

On power up the module begins performing the following logical functions:

- 1 Initialize hardware components
 - Initialize ControlLogix backplane driver
 - Test and Clear all RAM
 - Initialize the serial communication ports
- 2 Reads configuration from Compact Flash Disk
- 3 Initialize Module Register space
- 4 Enable Slave Driver on selected ports

After the module has received the Module Configuration, the module will begin communicating with other nodes on the network, depending on the configuration.

Main Logic Loop

Upon completing the power up configuration process, the module enters an infinite loop that performs the functions shown in the following diagram.

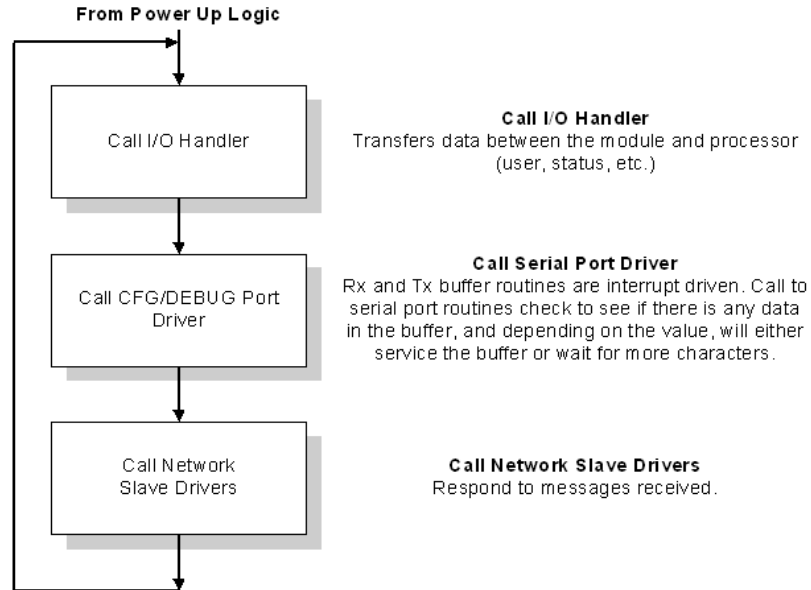

ControlLogix Processor Not in Run

Whenever the module detects that the processor has gone out of the Run mode (that is, Fault or PGM), backplane communications will halt between processor and module but not on the WA-PWP network. When the processor is returned to a running state, the module will resume communication with the Processor.

Backplane Data Transfer

The MVI56-WA-PWP module communicates directly over the ControlLogix backplane. Data is paged between the module and the ControlLogix processor across the backplane using the module's input and output images. The update frequency of the images is determined by the scheduled scan rate defined by the user for the module and the communication load on the module. Typical updates are in the range of 1 to 10 milliseconds.

This bi-directional transference of data is accomplished by the module filling in data in the module's input image to send to the processor. Data in the input image is placed in the Controller Tags in the processor by the ladder logic. The input image for the module is set to 250 words. This large data area permits fast throughput of data between the module and the processor.

The processor inserts data into the module's output image to transfer to the module. The module's program extracts the data and places it in the module's internal database. The output image for the module is set to 248 words. This large data area permits fast throughput of data from the processor to the module.

The following illustration shows the data transfer method used to move data between the ControlLogix processor, the MVI56-WA-PWP module and the PWP network.

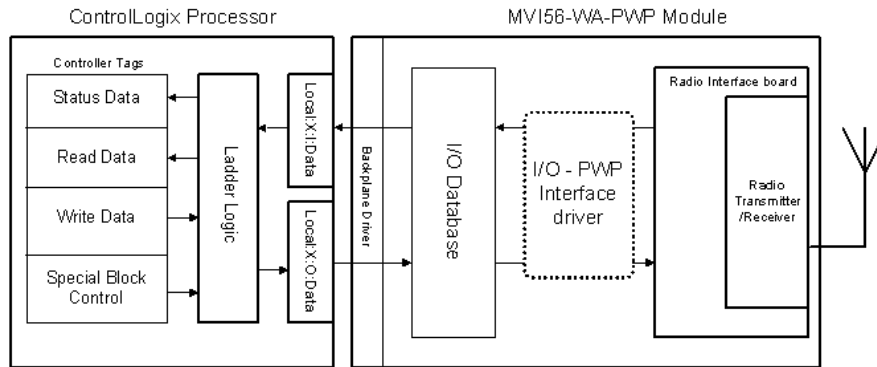

All data transferred between the module and the processor over the backplane is through the input and output images. Ladder logic must be written in the ControlLogix processor to interface the input and output image data with data defined in the Controller Tags. All data used by the module is stored in its internal database. The following illustration shows the layout of the database:

Module's Internal Database Structure

4000 registers for user data

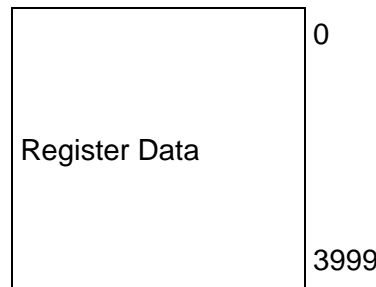

Data contained in this database is paged through the input and output images by coordination of the ControlLogix ladder logic and the MVI56-WA-PWP module's program. Up to 248 words of data can be transferred from the module to the processor at a time. Up to 247 words of data can be transferred from the processor to the module. The read and write block identification codes in each data block determine the function to be performed or the content of the data block. The module uses the following block numbers:

Block Range	Descriptions
-1 or 0	Empty Data Blocks
1 to 20	Data Read or Write Blocks
2000	CP Status Data
9250	General Status Data
9998	Warm-boot control block
9999	Cold-boot control block

Each image has a defined structure depending on the data content and the function of the data transfer.

5.2.5 Normal Data Transfer

Normal data transfer includes the paging of the user data found in the module's internal database in registers 0 to 3999 and the status data. These data are transferred through read (input image) and write (output image) blocks. Refer to the **Module Configuration** and **Ladder Logic** sections for a description of the data objects used with the blocks and the ladder logic required. The structure and function of each block is discussed in the following topics.

Read Block

These blocks of data transfer information from the module to the ControlLogix processor and transfer output (control) data sent to the module from the remote master unit. The structure of the input image used to transfer this data is shown in the following table.

Words	Description
0	Reserved
1	Block write ID requested
2 to 201	Input data
202	Program scan counter
203	Block write counter
204	Block read counter
205	Block parse counter
206	Block error counter
207	SNTP valid time
208	SNTP request count
209	SNTP response count
210	SNTP computation count
211	SNTP set count
212	SNTP timeout error count
213	SNTP seconds (LSW)
214	SNTP seconds (MSW)
215	SNTP microseconds (LSW)
216	SNTP microseconds (MSW)
217	Radio Packets In (LSW)
218	Radio Packets In (MSW)
219	Radio Packets Out (LSW)
220	Radio Packets Out (MSW)
221	Radio Bytes In (LSW)
222	Radio Bytes In (MSW)
223	Radio Bytes Out (LSW)
224	Radio Bytes Out (MSW)
225	Radio Errors In (LSW)
226	Radio Errors In (MSW)
227	Radio Errors Out (LSW)

Words	Description
228	Radio Errors Out (MSW)
229	Radio Packets Dropped (LSW)
230	Radio Packets Dropped (MSW)
231	Radio Port Status
232	Radio Tx rate
233	Radio Comm Quality
234	Radio Signal Level
235	Radio Noise Level
236	Radio Channel Number
237 to 248	Reserved
249	Block read ID

The Read Block ID is an index value used to determine the location of where the data will be placed in the ControlLogix processor controller tag array of module read data. Each transfer can move up to 200 words (block offsets 2 to 201) of data. In addition to moving user data, the block also contains status data for the module. This last set of data is transferred with each new block of data and can be used for module diagnostics.

The Write Block ID associated with the block requests data from the ControlLogix processor. Under normal, program operation, the module sequentially sends read blocks and requests write blocks. For example, if three read and two write blocks are used with the application, the sequence will be as follows:

R1W1 → R2W2 → R3W1 → R1W2 → R2W1 → R3W2 → R1W1 →

This sequence will continue until interrupted by other write block numbers sent by the controller or operator control through the module's Configuration/Debug port.

Write Block

These blocks of data transfer information from the ControlLogix processor to the module and source the input (monitored) data to be used by the remote master. The structure of the output image used to transfer this data is shown in the following table.

Words	Description
0	Block write ID
1 to 200	Output data
201 to 247	Reserved

The Write Block ID is an index value used to determine the location in the module's database where the data will be placed. Each transfer can move up to 200 words (block offsets 1 to 200) of data.

5.2.6 Command Control Blocks

Command control blocks are special blocks used to control the module. The current version of the software supports the following command control blocks.

Code	Description
-1 or 0	Empty data blocks
1 to 20	Data read or write blocks
2000	C/P status data
9250	General status data
9998	Warm boot module (same effect as 9999)
9999	Cold boot module

C/P Status Data (Block 2000)

Block 2000 Request

Words	Description
0	2000 Command Block ID
1	Number of C/P messages (1 to 17)
2	First C/P index (0 to 99)
3 to 247	Reserved

Block 2000 Response

Words	Description
0	Reserved
1	Block write ID requested
2	Number of C/P messages (0 to 17) Will be set to 0 if error in request.
3	First C/P index (0 to 99)
4 to 17	C/P Status Data
18 to 31	C/P Status Data
32 to 45	C/P Status Data
46 to 59	C/P Status Data
60 to 73	C/P Status Data
74 to 87	C/P Status Data
88 to 101	C/P Status Data
102 to 115	C/P Status Data
116 to 129	C/P Status Data
130 to 143	C/P Status Data
144 to 157	C/P Status Data
158 to 171	C/P Status Data
172 to 185	C/P Status Data
186 to 199	C/P Status Data
200 to 213	C/P Status Data
214 to 227	C/P Status Data
228 to 241	C/P Status Data
242 to 248	Reserved
249	2000 Command Block ID

Block 2000 C/P Status Data Format

Words	Description
0	Status (0=invalid, 1=producing/healthy, 2=pending/unhealthy)
1	Status bit mapped (bit0=error or invalid, bit1=not time synchronized, bits 2 to 15 reserved)
2	Number of times C/P (LSW)
3	Number of times C/P (MSW)
4	Missed count (LSW)
5	Missed count (MSW)
6	Refresh count error (LSW)
7	Refresh count error (MSW)
8	Invalid error bit set by producer
9	Time sync error set by producer
10	Short message error in exchange
11	Long message error in exchange
12	Protocol PVN not set to 1
13	Configuration signature not set correctly

Block 2000 Request

Words	Description
0	2000 Command Block ID
1	Number of C/P messages (1 to 17)
2	First C/P index (0 to 99)
3 to 247	Reserved

Block 2000 Response

Words	Description
0	Reserved
1	Block write ID requested
2	Number of C/P messages (0 to 17) Will be set to 0 if error in request.
3	First C/P index (0 to 99)
4 to 17	C/P Status Data
18 to 31	C/P Status Data
32 to 45	C/P Status Data
46 to 59	C/P Status Data
60 to 73	C/P Status Data
74 to 87	C/P Status Data
88 to 101	C/P Status Data
102 to 115	C/P Status Data
116 to 129	C/P Status Data
130 to 143	C/P Status Data
144 to 157	C/P Status Data
158 to 171	C/P Status Data

Words	Description
172 to 185	C/P Status Data
186 to 199	C/P Status Data
200 to 213	C/P Status Data
214 to 227	C/P Status Data
228 to 241	C/P Status Data
242 to 248	Reserved
249	2000 Command Block ID

Block 2000 C/P Status Data Format

Words	Description
0	Status (0=invalid, 1=producing/healthy, 2=pending/unhealthy)
1	Status bit mapped (bit0=error or invalid, bit1=not time synchronized, bits 2 to 15 reserved)
2	Number of times C/P (LSW)
3	Number of times C/P (MSW)
4	Missed count (LSW)
5	Missed count (MSW)
6	Refresh count error (LSW)
7	Refresh count error (MSW)
8	Invalid error bit set by producer
9	Time sync error set by producer
10	Short message error in exchange
11	Long message error in exchange
12	Protocol PVN not set to 1
13	Configuration signature not set correctly

General Status (Block 9250)

Block 9250 Request Block (General Status)

Words	Description
0	Command/Control Sequence Trigger
1	9250 Command code value
2 to 63	Command/Control data
64 to n	Output data

Block 9250 Response Block (General Status)

Words	Description
0	Command/Control Sequence Trigger
1	9250 Command code value
2	Program scan counter
3	Product code bytes 0 & 1
4	Product code bytes 2 & 3
5	Revision bytes 0 & 1
6	Revision bytes 2 & 3

Words	Description
7	Op bytes 0 & 1
8	Op bytes 2 & 3
9	Run bytes 0 & 1
10	Run bytes 2 & 3
11	Block write counter
12	Block read counter
13	Block parse counter
14	Block error counter
15	SNTP valid time
16	SNTP request count
17	SNTP response count
18	SNTP computation count
19	SNTP set count
20	SNTP timeout error count
21	SNTP seconds (LSW)
22	SNTP seconds (MSW)
23	SNTP microseconds (LSW)
24	SNTP microseconds (MSW)
25 to 248	Reserved
249	9250 Command Code Value

Block 9250 Request Block (General Status)

Words	Description
0	9250 Command code value
1 to 247	Reserved

Block 9250 Response Block (General Status)

Words	Description
0	Reserved
1	Block write ID requested
2	Program scan counter
3	Product code bytes 0 & 1
4	Product code bytes 2 & 3
5	Revision bytes 0 & 1
6	Revision bytes 2 & 3
7	Op bytes 0 & 1
8	Op bytes 2 & 3
9	Run bytes 0 & 1
10	Run bytes 2 & 3
11	Block write counter
12	Block read counter
13	Block parse counter

Words	Description
14	Block error counter
15	SNTP valid time
16	SNTP request count
17	SNTP response count
18	SNTP computation count
19	SNTP set count
20	SNTP timeout error count
21	SNTP seconds (LSW)
22	SNTP seconds (MSW)
23	SNTP microseconds (LSW)
24	SNTP microseconds (MSW)
25	Radio Packets In (LSW)
26	Radio Packets In (MSW)
27	Radio Packets Out (LSW)
28	Radio Packets Out (MSW)
29	Radio Bytes In (LSW)
30	Radio Bytes In (MSW)
31	Radio Bytes Out (LSW)
32	Radio Bytes Out (MSW)
33	Radio Errors In (LSW)
34	Radio Errors In (MSW)
35	Radio Errors Out (LSW)
36	Radio Errors Out (MSW)
37	Radio Packets Dropped (LSW)
38	Radio Packets Dropped (MSW)
39	Radio Port Status
40	Radio LED output & Signal LED output
41	Radio Link & Data LED output
42	SSID bytes 0 & 1
43	SSID bytes 2 & 3
44	SSID bytes 4 & 5
45	SSID bytes 6 & 7
46	SSID bytes 8 & 9
47	SSID bytes 10 & 11
48	SSID bytes 12 & 13
49	SSID bytes 14 & 15
50	SSID bytes 16 & 17
51	SSID bytes 18 & 19
52	SSID bytes 20 & 21
53	SSID bytes 22 & 23
54	SSID bytes 24 & 25

Words	Description
55	SSID bytes 26 & 27
56	SSID bytes 28 & 29
57	SSID bytes 30 & 31
58	SSID bytes 32 & 33
59	Radio Tx rate
60	Radio Comm Quality
61	Radio Signal Level
62	Radio Noise Level
63	Radio Channel Number
64 to 248	Reserved
249	9250 Command code value

Software Reset (Block 9998/9999)

This block is sent from the ControlLogix processor to the module (output image) when the module is required to perform a warm-boot (software reset) operation. This block is commonly sent to the module any time configuration data modifications are made. This will force the module to read the new configuration information and to restart. The structure of the control block is shown in the following table.

Offset	Description	Length
0	9998 or 9999	1
1 to 247	Spare	247

Because many of the parameters set in the configuration file require the program to restart, this function works the same as the cold-boot function. It will cause the module to exit and restart the program.

5.3 Jumper and Wiring Settings

5.3.1 RS-232 Configuration/Debug Port

This port is physically an RJ45 connection. An RJ45 to DB-9 adapter cable is included with the module. This port permits a PC based terminal emulation program to view configuration and status data in the module and to control the module. The cable for communications on this port is shown in the following diagram:

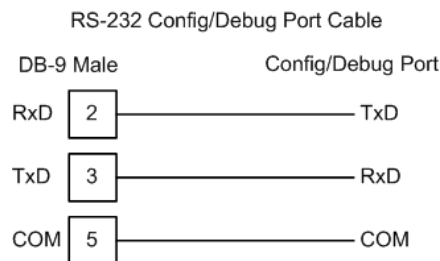

Disabling the RSLinx Driver for the Com Port on the PC

The communication port driver in RSLinx can occasionally prevent other applications from using the PC's COM port. If you are not able to connect to the module's configuration/debug port using ProSoft Configuration Builder (PCB), HyperTerminal or another terminal emulator, follow these steps to disable the RSLinx Driver.

- 1 Open RSLinx and go to Communications>RSWho
- 2 Make sure that you are not actively browsing using the driver that you wish to stop. The following shows an actively browsed network:

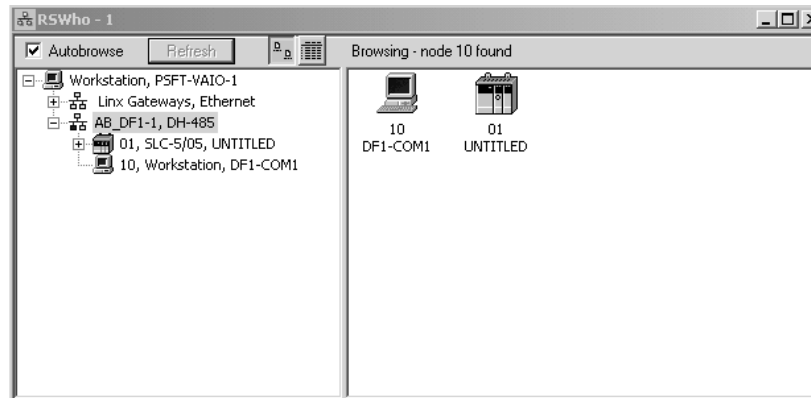

- 3 Notice how the DF1 driver is opened, and the driver is looking for a processor on node 1. If the network is being browsed, then you will not be able to stop this driver. To stop the driver your RSWHo screen should look like this:

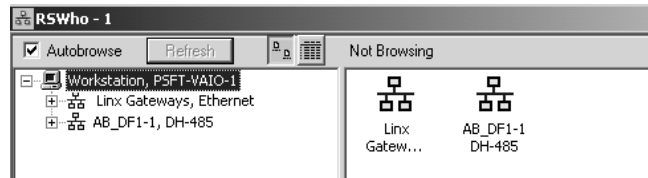

Branches are displayed or hidden by clicking on the  or the  icons.



- 4 When you have verified that the driver is not being browsed, go to **Communications>Configure Drivers**

You may see something like this:

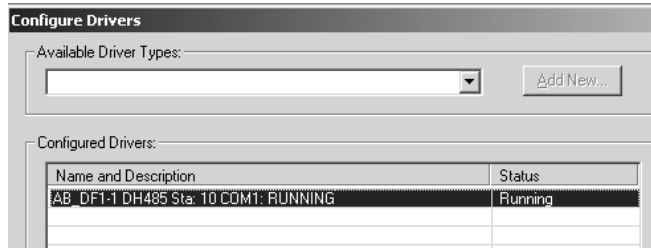

If you see the status as running, you will not be able to use this com port for anything other than communication to the processor. To stop the driver press the "Stop" on the side of the window:



5 After you have stopped the driver you will see the following:

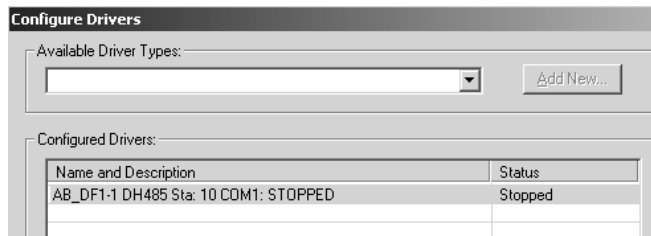

6 Upon seeing this, you may now use that com port to connect to the debug port of the module.

Note: You may need to shut down and restart your PC before it will allow you to stop the driver (usually only on Windows NT machines). If you have followed all of the above steps, and it will not stop the driver, then make sure you do not have RSLogix open. If RSLogix is not open, and you still cannot stop the driver, then reboot your PC.

5.3.2 DB9 to RJ45 Adaptor (Cable 14)

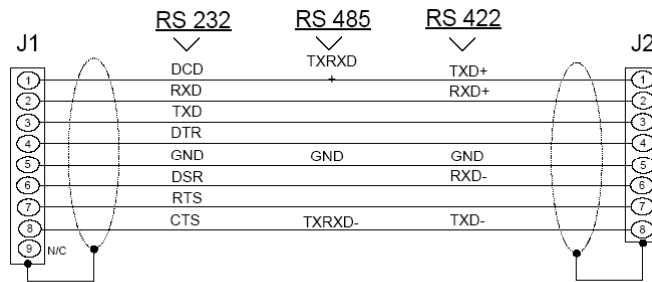
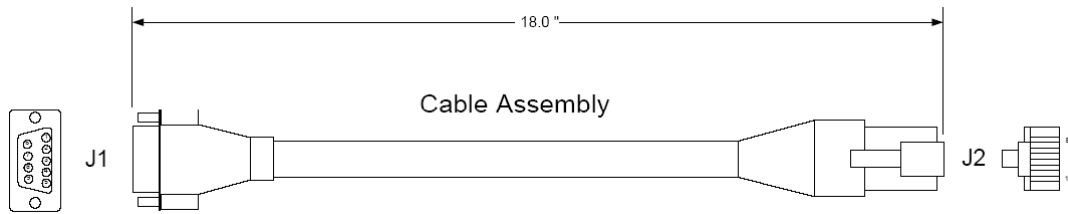

Wiring Diagram

6 Support, Service & Warranty

In This Chapter

- ❖ How to Contact Us: Technical Support..... 81
- ❖ Return Material Authorization (RMA) Policies and Conditions..... 82
- ❖ LIMITED WARRANTY..... 83

ProSoft Technology, Inc. (ProSoft) is committed to providing the most efficient and effective support possible. Before calling, please gather the following information to assist in expediting this process:

- 1 Product Version Number
- 2 System architecture
- 3 Network details

If the issue is hardware related, we will also need information regarding:

- 1 Module configuration and contents of file
 - Module Operation
 - Configuration/Debug status information
 - LED patterns
- 2 Information about the processor and user data files as viewed through and LED patterns on the processor.
- 3 Details about the serial devices interfaced, if any.

6.1 How to Contact Us: Technical Support

Internet	Web Site: http://www.prosoft-technology.com/support E-mail address: support@prosoft-technology.com
-----------------	---

Asia Pacific

+603.7724.2080, support.asia@prosoft-technology.com
Languages spoken include: Chinese, English

Europe (location in Toulouse, France)

+33 (0) 5.34.36.87.20, support.EMEA@prosoft-technology.com
Languages spoken include: French, English

North America/Latin America (excluding Brasil) (location in California)

+1.661.716.5100, support@prosoft-technology.com
Languages spoken include: English, Spanish

For technical support calls within the United States, an after-hours answering system allows pager access to one of our qualified technical and/or application support engineers at any time to answer your questions.

Brasil (location in Sao Paulo)

+55-11-5084-5178, eduardo@prosoft-technology.com
Languages spoken include: Portuguese, English

6.2 Return Material Authorization (RMA) Policies and Conditions

The following RMA Policies and Conditions (collectively, "RMA Policies") apply to any returned Product. These RMA Policies are subject to change by ProSoft without notice. For warranty information, see "Limited Warranty". In the event of any inconsistency between the RMA Policies and the Warranty, the Warranty shall govern.

6.2.1 All Product Returns:

- a) In order to return a Product for repair, exchange or otherwise, the Customer must obtain a Returned Material Authorization (RMA) number from ProSoft and comply with ProSoft shipping instructions.
- b) In the event that the Customer experiences a problem with the Product for any reason, Customer should contact ProSoft Technical Support at one of the telephone numbers listed above (page 81). A Technical Support Engineer will request that you perform several tests in an attempt to isolate the problem. If after completing these tests, the Product is found to be the source of the problem, we will issue an RMA.
- c) All returned Products must be shipped freight prepaid, in the original shipping container or equivalent, to the location specified by ProSoft, and be accompanied by proof of purchase and receipt date. The RMA number is to be prominently marked on the outside of the shipping box. Customer agrees to insure the Product or assume the risk of loss or damage in transit. Products shipped to ProSoft using a shipment method other than that specified by ProSoft or shipped without an RMA number will be returned to the Customer, freight collect. Contact ProSoft Technical Support for further information.
- d) A 10% restocking fee applies to all warranty credit returns whereby a Customer has an application change, ordered too many, does not need, etc.

6.2.2 Procedures for Return of Units Under Warranty:

A Technical Support Engineer must approve the return of Product under ProSoft's Warranty:

- a) A replacement module will be shipped and invoiced. A purchase order will be required.
- b) Credit for a product under warranty will be issued upon receipt of authorized product by ProSoft at designated location referenced on the Return Material Authorization.

6.2.3 Procedures for Return of Units Out of Warranty:

- a) Customer sends unit in for evaluation
- b) If no defect is found, Customer will be charged the equivalent of \$100 USD, plus freight charges, duties and taxes as applicable. A new purchase order will be required.

- c) If unit is repaired, charge to Customer will be 30% of current list price (USD) plus freight charges, duties and taxes as applicable. A new purchase order will be required or authorization to use the purchase order submitted for evaluation fee.

The following is a list of non-repairable units:

- 3150 - All
- 3750
- 3600 - All
- 3700
- 3170 - All
- 3250
- 1560 - Can be repaired, only if defect is the power supply
- 1550 - Can be repaired, only if defect is the power supply
- 3350
- 3300
- 1500 - All

6.2.4 Purchasing Warranty Extension:

- a) ProSoft's standard warranty period is three (3) years from the date of shipment as detailed in "Limited Warranty (page 83)". The Warranty Period may be extended at the time of equipment purchase for an additional charge, as follows:
- Additional 1 year = 10% of list price
 - Additional 2 years = 20% of list price
 - Additional 3 years = 30% of list price

6.3 LIMITED WARRANTY

This Limited Warranty ("Warranty") governs all sales of hardware, software and other products (collectively, "Product") manufactured and/or offered for sale by ProSoft, and all related services provided by ProSoft, including maintenance, repair, warranty exchange, and service programs (collectively, "Services"). By purchasing or using the Product or Services, the individual or entity purchasing or using the Product or Services ("Customer") agrees to all of the terms and provisions (collectively, the "Terms") of this Limited Warranty. All sales of software or other intellectual property are, in addition, subject to any license agreement accompanying such software or other intellectual property.

6.3.1 What Is Covered By This Warranty

- a) *Warranty On New Products:* ProSoft warrants, to the original purchaser, that the Product that is the subject of the sale will (1) conform to and perform in accordance with published specifications prepared, approved and issued by ProSoft, and (2) will be free from defects in material or workmanship; provided these warranties only cover Product that is sold as new. This Warranty expires three years from the date of shipment (the "Warranty Period"). If the Customer discovers within the Warranty Period a failure of the Product to conform to specifications, or a defect in material or workmanship of the Product, the Customer must promptly notify ProSoft by fax, email or telephone. In no event may that notification be received by ProSoft later than 39 months. Within a reasonable time after notification, ProSoft will correct any failure of the Product to conform to specifications or any defect in material or workmanship of the Product, with either new or used replacement parts. Such repair, including both parts and labor, will be performed at ProSoft's expense. All warranty service will be performed at service centers designated by ProSoft.
- b) *Warranty On Services:* Materials and labor performed by ProSoft to repair a verified malfunction or defect are warranted in the terms specified above for new Product, provided said warranty will be for the period remaining on the original new equipment warranty or, if the original warranty is no longer in effect, for a period of 90 days from the date of repair.

6.3.2 What Is Not Covered By This Warranty

- a) ProSoft makes no representation or warranty, expressed or implied, that the operation of software purchased from ProSoft will be uninterrupted or error free or that the functions contained in the software will meet or satisfy the purchaser's intended use or requirements; the Customer assumes complete responsibility for decisions made or actions taken based on information obtained using ProSoft software.
- b) This Warranty does not cover the failure of the Product to perform specified functions, or any other non-conformance, defects, losses or damages caused by or attributable to any of the following: (i) shipping; (ii) improper installation or other failure of Customer to adhere to ProSoft's specifications or instructions; (iii) unauthorized repair or maintenance; (iv) attachments, equipment, options, parts, software, or user-created programming (including, but not limited to, programs developed with any IEC 61131-3, "C" or any variant of "C" programming languages) not furnished by ProSoft; (v) use of the Product for purposes other than those for which it was designed; (vi) any other abuse, misapplication, neglect or misuse by the Customer; (vii) accident, improper testing or causes external to the Product such as, but not limited to, exposure to extremes of temperature or humidity, power failure or power surges; or (viii) disasters such as fire, flood, earthquake, wind and lightning.

- c) The information in this Agreement is subject to change without notice. ProSoft shall not be liable for technical or editorial errors or omissions made herein; nor for incidental or consequential damages resulting from the furnishing, performance or use of this material. The user guide included with your original product purchase from ProSoft contains information protected by copyright. No part of the guide may be duplicated or reproduced in any form without prior written consent from ProSoft.

6.3.3 Disclaimer Regarding High Risk Activities

Product manufactured or supplied by ProSoft is not fault tolerant and is not designed, manufactured or intended for use in hazardous environments requiring fail-safe performance including and without limitation: the operation of nuclear facilities, aircraft navigation of communication systems, air traffic control, direct life support machines or weapons systems in which the failure of the product could lead directly or indirectly to death, personal injury or severe physical or environmental damage (collectively, "high risk activities"). ProSoft specifically disclaims any express or implied warranty of fitness for high risk activities.

6.3.4 Intellectual Property Indemnity

Buyer shall indemnify and hold harmless ProSoft and its employees from and against all liabilities, losses, claims, costs and expenses (including attorney's fees and expenses) related to any claim, investigation, litigation or proceeding (whether or not ProSoft is a party) which arises or is alleged to arise from Buyer's acts or omissions under these Terms or in any way with respect to the Products. Without limiting the foregoing, Buyer (at its own expense) shall indemnify and hold harmless ProSoft and defend or settle any action brought against such Companies to the extent based on a claim that any Product made to Buyer specifications infringed intellectual property rights of another party. ProSoft makes no warranty that the product is or will be delivered free of any person's claiming of patent, trademark, or similar infringement. The Buyer assumes all risks (including the risk of suit) that the product or any use of the product will infringe existing or subsequently issued patents, trademarks, or copyrights.

- a) Any documentation included with Product purchased from ProSoft is protected by copyright and may not be duplicated or reproduced in any form without prior written consent from ProSoft.
- b) ProSoft's technical specifications and documentation that are included with the Product are subject to editing and modification without notice.
- c) Transfer of title shall not operate to convey to Customer any right to make, or have made, any Product supplied by ProSoft.
- d) Customer is granted no right or license to use any software or other intellectual property in any manner or for any purpose not expressly permitted by any license agreement accompanying such software or other intellectual property.

- e) Customer agrees that it shall not, and shall not authorize others to, copy software provided by ProSoft (except as expressly permitted in any license agreement accompanying such software); transfer software to a third party separately from the Product; modify, alter, translate, decode, decompile, disassemble, reverse-engineer or otherwise attempt to derive the source code of the software or create derivative works based on the software; export the software or underlying technology in contravention of applicable US and international export laws and regulations; or use the software other than as authorized in connection with use of Product.
- f) **Additional Restrictions Relating To Software And Other Intellectual Property**

In addition to compliance with the Terms of this Warranty, Customers purchasing software or other intellectual property shall comply with any license agreement accompanying such software or other intellectual property. Failure to do so may void this Warranty with respect to such software and/or other intellectual property.

6.3.5 Disclaimer of all Other Warranties

The Warranty set forth in What Is Covered By This Warranty (page 84) are in lieu of all other warranties, express or implied, including but not limited to the implied warranties of merchantability and fitness for a particular purpose.

6.3.6 Limitation of Remedies **

In no event will ProSoft or its Dealer be liable for any special, incidental or consequential damages based on breach of warranty, breach of contract, negligence, strict tort or any other legal theory. Damages that ProSoft or its Dealer will not be responsible for included, but are not limited to: Loss of profits; loss of savings or revenue; loss of use of the product or any associated equipment; loss of data; cost of capital; cost of any substitute equipment, facilities, or services; downtime; the claims of third parties including, customers of the Purchaser; and, injury to property.

** Some areas do not allow time limitations on an implied warranty, or allow the exclusion or limitation of incidental or consequential damages. In such areas, the above limitations may not apply. This Warranty gives you specific legal rights, and you may also have other rights which vary from place to place.

6.3.7 Time Limit for Bringing Suit

Any action for breach of warranty must be commenced within 39 months following shipment of the Product.

6.3.8 No Other Warranties

Unless modified in writing and signed by both parties, this Warranty is understood to be the complete and exclusive agreement between the parties, suspending all oral or written prior agreements and all other communications between the parties relating to the subject matter of this Warranty, including statements made by salesperson. No employee of ProSoft or any other party is authorized to make any warranty in addition to those made in this Warranty. The Customer is warned, therefore, to check this Warranty carefully to see that it correctly reflects those terms that are important to the Customer.

6.3.9 Allocation of Risks

This Warranty allocates the risk of product failure between ProSoft and the Customer. This allocation is recognized by both parties and is reflected in the price of the goods. The Customer acknowledges that it has read this Warranty, understands it, and is bound by its Terms.

6.3.10 Controlling Law and Severability

This Warranty shall be governed by and construed in accordance with the laws of the United States and the domestic laws of the State of California, without reference to its conflicts of law provisions. If for any reason a court of competent jurisdiction finds any provisions of this Warranty, or a portion thereof, to be unenforceable, that provision shall be enforced to the maximum extent permissible and the remainder of this Warranty shall remain in full force and effect. Any cause of action with respect to the Product or Services must be instituted in a court of competent jurisdiction in the State of California.

Index

I

[Backplane Configuration] • 27
 [Radio Configuration] • 28
 [RADIO PWP Exchanges] • 31
 [Radio PWP Multicast Group List] • 35
 [Radio SNTP Client] • 29

A

Adding a Module • 24
 Adding a Project • 23
 Agency Approval & Certification • 3
 All Product Returns • 82
 Allocation of Risks • 87

B

Backplane Data Transfer • 45, 67
 Battery Life Advisory • 2
 Block 2000 C/P Status Data Format • 73
 Block 2000 Request • 72
 Block 2000 Response • 72
 Block 9250 Request Block (General Status) • 74
 Block 9250 Response Block (General Status) • 74

C

C/P Status Data (Block 2000) • 71
 Cast Type • 31
 Channel • 37
 Choose the Controller Type • 16
 Clearing a Fault Condition • 59
 Command Control Blocks • 71
 Comment Entries • 26
 Configuring RSLinx • 19
 Configuring the MVI56-WA-PWP Module • 21
 Connect your PC to the Processor • 14
 Continuously Monitoring Radio Status • 54
 Controlling Law and Severability • 87
 ControlLogix Processor Not in Run • 67
 Create_IBSS • 37
 CS Major, CS Minor • 34

D

Database Register • 30
 Database View Menu • 51
 DB Reg • 32
 DB9 to RJ45 Adaptor (Cable 14) • 79
 Diagnostics and Troubleshooting • 7, 45
 Disabling the RSLinx Driver for the Com Port on the PC • 77
 Disclaimer of all Other Warranties • 86
 Disclaimer Regarding High Risk Activities • 85
 Displaying the Current Page of Registers Again • 52
 Download the Sample Program to the Processor • 18

E

Enable_Encryption • 37
 Exch ID • 33
 Exch Type • 31
 Exchange Configuration Form • 80
 Exiting the Program • 51

F

Failure Flag Count • 28
 Functional Overview • 7, 63
 Functional Specifications • 61

G

General Concepts • 66
 General Status (Block 9250) • 73
 Going Ahead Two Pages of Data • 57
 Going Back Two Pages of Data • 57
 Guide to the MVI56-WA-PWP User Manual • 7

H

How to Contact Us
 Technical Support • 81, 82

I

Important Installation Instructions
 Radio Modules • 2
 Install ProSoft Configuration Builder Software • 10
 Install the Antenna • 12
 Install the Module in the Rack • 12
 Intellectual Property Indemnity • 85
 IP Address • 33

J

Jumper and Wiring Settings • 76

K

Keystrokes • 48

L

LED Status Indicators • 7, 58
 Limitation of Remedies ** • 86
 LIMITED WARRANTY • 83

M

Main Logic Loop • 67
 Main Menu • 48
 Module Entries • 25
 Moving Back Through 5 Pages of Registers • 52

N

Navigation • 47
 Network Menu • 50, 54
 Network_Name_(SSID) • 36
 No Other Warranties • 87
 Normal Data Transfer • 69
 NTP Server IP Address • 30

O

- Open the Sample Ladder Logic in RSLogix • 15
- Opening the Database Menu • 49
- Opening the Map Data Menu • 50
- Opening the Network Menu • 50
- Opening the Producer/Consumer List Menu • 55
- Opening the PWP Menu • 50
- Opening the Radio Menu • 49
- Opening the Status Data Menu • 56

P

- P/C Time • 32
- Package Contents • 10
- Pinouts • 76, 79
- Printing a Configuration File • 26
- Procedures for Return of Units Out of Warranty: • 82
- Procedures for Return of Units Under Warranty: • 82
- Product Specifications • 7, 61
- ProSoft Configuration Builder • 21
- ProSoft® Product Documentation • 3
- Purchasing Warranty Extension: • 83
- PWP Consumer • 65
- PWP Menu • 55
- PWP Producer • 65

R

- Radio Ethernet Configuration (WATTCP) • 36
- Radio Menu • 53
- Radio PWP Exchange Command List Example • 35
- Radio PWP Producer/Consumer List Menu • 56
- Radio_Default_Gateway • 36
- Radio_IP • 36
- Radio_Subnet_Mask • 36
- Read Block • 69
- Read Register Count • 27
- Read Register Start • 27
- Reading Status Data from the Module • 45
- Redisplaying the Current Page • 57
- Redisplaying the Menu • 48, 56, 57
- Reference • 7, 61
- Reg Count • 32
- Required Hardware • 45
- Resetting diagnostic data • 49
- Return Material Authorization (RMA) Policies and Conditions • 82
- Returning to the Main Menu • 52, 54, 55, 56
- Returning to the Previous Menu • 57
- RF LEDs • 58
- RS-232 Configuration/Debug Port • 76
- Rules for CS Validation • 34

S

- Sample Ladder Logic • 14
- Save and Download the Configuration File to the 6104-WA-PDPM • 41
- Save and Download the Configuration File to the MVI56-WA-PWP • 39
- Select the Slot Number for the Module • 17
- Set Module Parameters • 25

- Set Up the Project • 22
- Setting Jumpers • 12
- Signal LED 1, 2, 3, 4 • 28
- Skipping 500 Registers of Data • 52
- Software Reset (Block 9998/9999) • 76
- Start Here • 7, 9
- Station_Name • 37
- Support, Service & Warranty • 7, 81
- Swap Code • 32
- System Requirements • 9

T

- The Configuration/Debug Menu • 46
- Time Limit for Bringing Suit • 86
- Time Zone • 30
- Transferring the Configuration File from MVI56 module to PC • 49
- Transferring WATTCP.CFG to the module • 54
- Transferring WATTCP.CFG to the PC • 55
- Transmit Rate • 29, 31, 33
- Transmit_WEP_Key • 38
- Troubleshooting • 60

U

- Underlying Protocol Requirements and Constraints • 63
- Use Daylight Savings Time • 30
- Using the Diagnostic Window in ProSoft Configuration Builder • 46

V

- Verify Data Exchange • 42
- Verify Radio Communications • 7, 39
- Viewing Data in ASCII (Text) Format • 52
- Viewing Data in Decimal Format • 52
- Viewing Data in Floating Point Format • 52
- Viewing Data in Hexadecimal Format • 52
- Viewing Module Configuration • 49
- Viewing Radio Configuration • 53
- Viewing Radio Status • 53
- Viewing Register Pages • 51
- Viewing SNTP Status • 50
- Viewing the Multicast Group List • 56
- Viewing the Next 100 Registers of Data • 52
- Viewing the Next Page of Data • 57
- Viewing the Previous 100 Registers of Data • 52
- Viewing the Previous Page of Data • 57
- Viewing the WATTCP.CFG file on the module • 55
- Viewing Version Information • 49

W

- Warm Booting the Module • 50
- WEP Key Rollover • 29
- WEP_Key_1 to WEP_Key_4 • 38
- What Is Covered By This Warranty • 84, 86
- What Is Not Covered By This Warranty • 84
- Write Block • 70
- Write Register Count • 27
- Write Register Start • 27

Y

Your Feedback Please • 3